

**iServer MicroServer™**

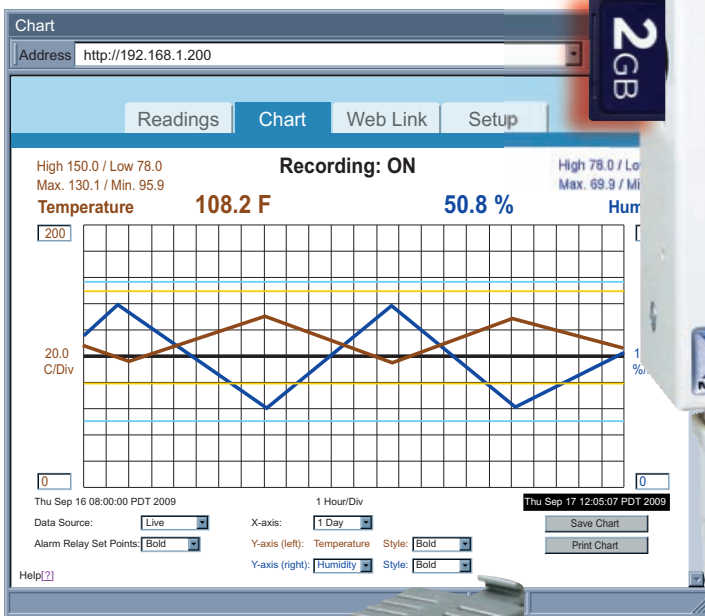

**Temperature & Relative Humidity**

- ✓ Web Server
- ✓ Alarms by Email or Text Message
- ✓ No Special Software Required
- ✓ iTHX-SD: Record Years of Data on Popular SD Cards



**iTHX-SD**



**iTHX-W3**



**iTHX-D3**

The **NEWPORT® iTHX** transmitter let's you monitor and record Temperature, Relative Humidity and Dew Point over an Ethernet network or the Internet with no special software except a Web Browser.

The iTHX serves Active Web Pages to display real time readings, display charts of temperature, humidity, and dew point or log data in standard data formats for use in a spreadsheet or data acquisition program such as Excel or Visual Basic.

The virtual chart viewed on the web page is a **JAVA™** Applet that records a chart over the LAN or Internet in real time. With the iTHX, there is no need to invest time.

# iServer MicroServer™

## Adjustable Charts

Chart scales are fully adjustable on the fly. For example, the chart can display one minute, one hour, one day, one week, one month or one year. Temperature and humidity can be charted across the full span (-40 to 124°C, and 0 to 100% RH) or within any narrow range such as (20 to 30°C).



**Adjustable Chart**

## Award-winning Technology

The NEWPORT iTHX is simple to install and use, and features NEWPORT's award-winning iServer technology that requires no special software except a Web Browser.

The iTHX connects to an Ethernet Network with a standard RJ45 connector and sends data in standard TCP/IP packets. It is easily configured with a simple menu using a Web Browser and can be password protected.

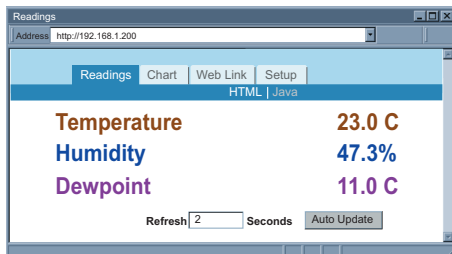

**Sensor Readings for iTHX-W3 or iTHX-D3**

From within an Ethernet LAN or over the Internet, the user simply types its IP address or an easy to remember name such as "CleanRm5" or "ServRoom" in any Web Browser, and the iTHX serves a Web Page with the current readings.

## Email Alarms

All NEWPORT iTHX models that are on a LAN that is connected to the Internet can trigger an alarm that can be sent by email to a user or a distribution list anywhere in the world, including text messages to cell phones and PDA's.

## Link to Web CAM or IP Camera

The Web page includes a link to a "Web Cam" or "IP camera" (not included). If you get a message about an alarm condition, you can quickly click on the link to view the actual scene over the Internet.

## Sensor and Calibration

The iTHX transmitters come complete with a temperature and humidity probe for measurement of a single location. NEWPORT offers a choice of industrial probes in 2" (with a 3' cable) or 5" length (with a 10' cable) instead of the commercial wand style probe which is designed for ambient indoor applications.

## Industrial Probes: iTHP-5, iTHP-2



Replacement Probes with Calibration Certificate available, just add: "- CAL-3-HU" to your probe

It is not necessary to take the iTHX out of service for routine calibration. The temperature / humidity sensors are interchangeable and can be replaced for about the same cost as a typical calibration.

NEWPORT offers replacement probes with optional 3-point NIST traceable calibration certificates.

## Typical Applications

The iTHX is great for monitoring temperature + humidity in applications such as: clean rooms, computer rooms, HVAC systems, pharmaceutical and food processing and storage, hospitals, laboratories, semiconductor fabs, electronic assembly, warehousing, museums, manufacturing, green-houses, farm animal shelters, and many more.

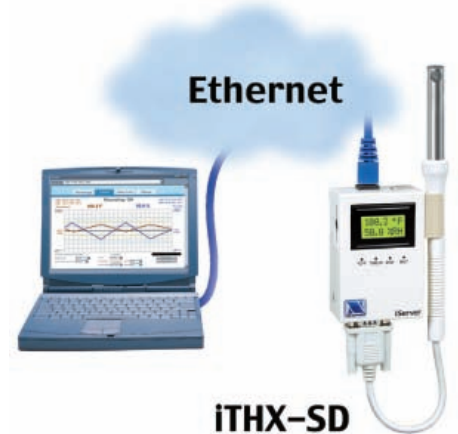

## NEW iTHX-SD with SD Flash Memory Card and LCD Display

The NEWPORT model iTHX-SD with LCD display, adds several valuable features in addition to the backlit local display of temperature and humidity.

## SD Flash Memory Card

The iTHX-SD comes complete with a removable 2 GB SD Flash Memory card that can store up to seven years of readings taken at ten second intervals.

## Records on SD Flash Cards

The data is recorded on widely available SD (Secure Digital) flash cards. The format is a simple text file that is easily imported to spread sheets and other programs.

It can be read on a PC or MAC with a USB card reader. You can also download the data remotely over an Ethernet network or the Internet.

## Alarm Relays

The iTHX-SD features two 1.5 Amp relays. With the easy Web-based setup page, the two relays can be programmed for any combination of temperature or humidity, and high or low set points. The relays can also be programmed to remain latched and require a manual reset if a limit is exceeded.

## Battery Backup

The iTHX-SD comes with a universal 100 to 240 Vac power adapter.

A standard 9 Volt Alkaline battery (also included) allows the device to log data for up to 2 days without external ac power. A failure on the Ethernet network will not interrupt data recording.

# Temperature + Humidity

## SENSOR SPECIFICATIONS

### RELATIVE HUMIDITY (RH)

**Accuracy/Range:**  $\pm 2\%$  for 10 to 90%;  
 $\pm 3\%$  for 5 to 10% and 90 to 95%;  
 $\pm 4\%$  for 0 to 5% and 95 to 100%  
**Non-linearity:**  $\pm 3\%$   
**Hysteresis:**  $\pm 1\%$  RH  
**Response Time:** 8 seconds, tau 63%  
**Repeatability:**  $\pm 0.1\%$   
**Resolution:** 0.1%, 12 bit

### TEMPERATURE (T)

#### Accuracy/Range\*

**Wand Probe:**  $\pm 0.5^\circ\text{C}$  for 5 to  $45^\circ\text{C}$   
( $\pm 1^\circ\text{F}$  for 41 to  $113^\circ\text{F}$ ); up to  $\pm 1^\circ\text{C}$  for  
0 to  $5^\circ\text{C}$  and 45 to  $70^\circ\text{C}$  ( up  $\pm 2^\circ\text{F}$  for  
32 to  $41^\circ\text{F}$  and 113 to  $158^\circ\text{F}$ )  
**Industrial Probe:** (see chart in manual)  
 $\pm 0.5^\circ\text{C}$  for 5 to  $45^\circ\text{C}$   
( $\pm 1^\circ\text{F}$  for 41 to  $113^\circ\text{F}$ ); up to  $\pm 1.5^\circ\text{C}$   
for  $-40$  to  $5^\circ\text{C}$  and 45 to  $124^\circ\text{C}$   
(up to  $\pm 2.7^\circ\text{F}$  for  $-40$  to  $41^\circ\text{F}$  and  
113 to  $255^\circ\text{F}$ )

\*Note: extended temperature range is for industrial probe only, refer to the iServer's operating temperature spec

**Response Time:** 5 to 30 secs, tau 63%  
**Repeatability:**  $\pm 0.1\%$   
**Resolution:** 0.1°C, 14 bit

### PROBE PHYSICAL DIMENSIONS

#### Wand Probe iTHP-W-6

$\varnothing 19 \times 198$  mm lg (0.75 x 7.8" lg)  
Cable length 152 mm (6") with DB9 Connector  
Cable operating temp: 0 to  $80^\circ\text{C}$   
(32 to  $176^\circ\text{F}$ )

#### Industrial Probe iTHP-5, iTHP-2:

$\varnothing 16 \times 137$  mm lg or 51 mm lg  
( $\varnothing 0.63 \times 5"$  lg or 2" lg)  
Housing material: SS  
Cable length 3 m (10') or 0.9 m (3')  
Cable operating temperature:  
 $-40$  to  $125^\circ\text{C}$  ( $-40$  to  $257^\circ\text{F}$ )

## ISERVER SPECIFICATIONS

### INTERFACES

**Ethernet (RJ45):** Fixed or auto-negotiating 10/100BASE-T, Auto MDI/MDIX

**Sensor:** Digital 4-wire (DB9): iTHX-W3, iTHX-SD; removable 4 position screw terminal: iTHX-D3

### PROTOCOLS

TCP, UDP, SNMP, SMTP, NTP, ARP, ICMP, DHCP, DNS, HTTP, and Telnet

### LCD DISPLAY (iTHX-SD)

16 Digits 6mm (0.23")

### SD FLASH MEMORY CARD (iTHX-SD)

2 GB card: 8 months of data storage at 1 second recording intervals or 7 years at 10 second intervals

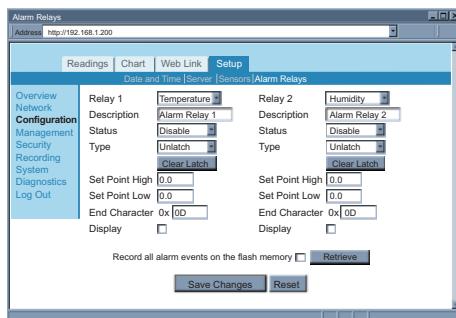

iTHX-SD Alarm Relays

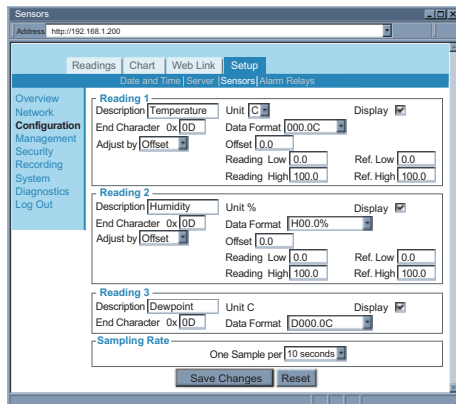

iTHX Sensor Configuration

### RELAY OUTPUTS (iTHX-SD)

Two Relays 1.5 A @ 30 Vdc

### EMBEDDED WEB SERVER

Serves WEB pages containing real-time data and live updated charts within definable time intervals

### SOFTWARE

OPC Server; macro for datalogging in Excel program; compatible with Windows operating systems

### POWER

**Input:** 9 to 12 Vdc: iTHX-SD;  
5 Vdc @ 200 mA max: iTHX-W3  
10 to 32 Vdc: iTHX-D3

### Safety Qualified ac power adapter:

**Nominal Output:** 9 Vdc @ 0.5A

**Input:** 100 to 240 Vac, 50/60Hz included: iTHX-SD

**Nominal Output:** 5Vdc @ 600 mA

**Input:** 100 to 240 Vac, 50/60Hz included: iTHX-W3

**Switching Power Supply** sold separately: iTHX-D3

### Back-up Battery:

9 Vdc, Alkaline for iTHX-SD

### ENVIRONMENTAL

Operating Temperature:  
0 to  $70^\circ\text{C}$  (32 to  $158^\circ\text{F}$ ) for iTHX-W3;  
 $-40$  to  $85^\circ\text{C}$  ( $-40$  to  $185^\circ\text{F}$ ) for iTHX-D3,  
iTHX-W3-2 or iTHX-W3-5  
0 to  $60^\circ\text{C}$  (32 to  $140^\circ\text{F}$ ) for iTHX-SD  
Battery:  $-18$  to  $55^\circ\text{C}$  (0 to  $131^\circ\text{F}$ )

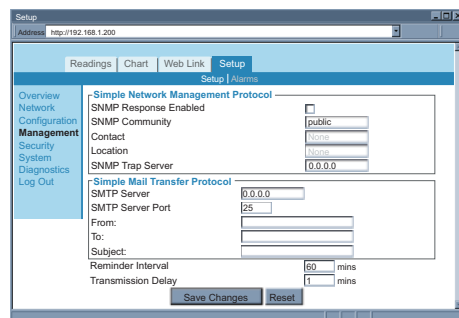

iTHX Management

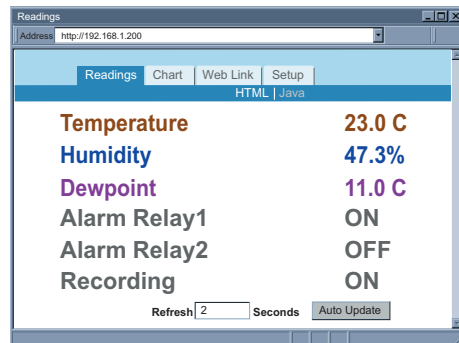

Sensor Readings on iTHX-SD

**ac Adapter:** 0 to  $40^\circ\text{C}$  (32 to  $104^\circ\text{F}$ )

**Storage Temperature:**  
 $-40$  to  $85^\circ\text{C}$  ( $-40$  to  $185^\circ\text{F}$ )

### PACKAGING

**Material:** Steel metal case with wall mount bracket: iTHX-SD;  
Valox 364 PBT case with wall mount bracket: iTHX-W3;  
Polycarbonate case with DIN Rail mount: iTHX-D3

| Time                  | Temperature | Humidity | Dewpoint | Error |
|-----------------------|-------------|----------|----------|-------|
| 10/15/2002 5:08:54 PM | 23.78       | 36.25    | 12.51    |       |
| 10/15/2002 5:09:04 PM | 23.65       | 36.50    | 12.50    |       |
| 10/15/2002 5:09:14 PM | 23.53       | 36.81    | 12.35    |       |
| 10/15/2002 5:09:24 PM | 23.41       | 37.25    | 12.42    |       |
| 10/15/2002 5:09:34 PM | 23.25       | 37.76    | 12.49    |       |
| 10/15/2002 5:09:44 PM | 23.01       | 38.00    | 12.40    |       |
| 10/15/2002 5:09:54 PM | 22.74       | 38.54    | 12.34    |       |
| 10/15/2002 5:09:59 PM | 22.51       | 38.67    | 12.27    |       |
| 10/15/2002 5:10:09 PM | 22.23       | 38.36    | 12.21    |       |
| 10/15/2002 5:10:19 PM | 22.02       | 38.72    | 12.05    |       |
| 10/15/2002 5:10:29 PM | 21.99       | 39.05    | 12.21    |       |
| 10/15/2002 5:10:34 PM | 21.96       | 40.05    | 12.24    |       |
| 10/15/2002 5:10:39 PM | 21.89       | 39.94    | 12.18    |       |
| 10/15/2002 5:10:44 PM | 21.84       | 39.84    | 12.09    |       |
| 10/15/2002 5:10:49 PM | 21.79       | 40.21    | 12.14    |       |
| 10/15/2002 5:10:54 PM | 21.71       | 40.57    | 12.06    |       |
| 10/15/2002 5:10:59 PM | 21.65       | 40.43    | 12.01    |       |
| 10/15/2002 5:11:05 PM | 21.54       | 41.54    | 12.42    |       |
| 10/15/2002 5:11:10 PM | 21.47       | 41.64    | 12.31    |       |

Datalogging Spreadsheet

NIST Traceable Calibration Certificate available.  
In compliance with ISO9001:2008, ISO10012-1, 1992(E), ANSI/NCSL Z540-1, 1994 and MIL-STD-45662A.

## MECHANICAL SPECIFICATIONS

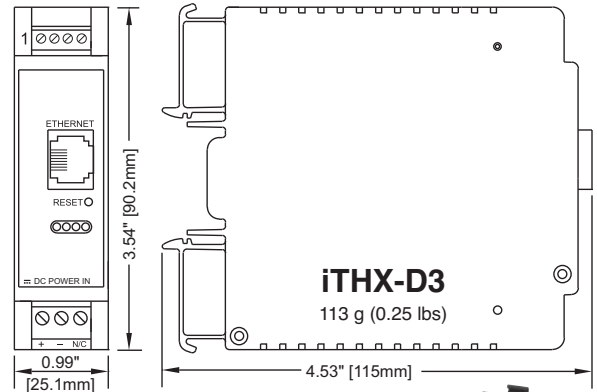
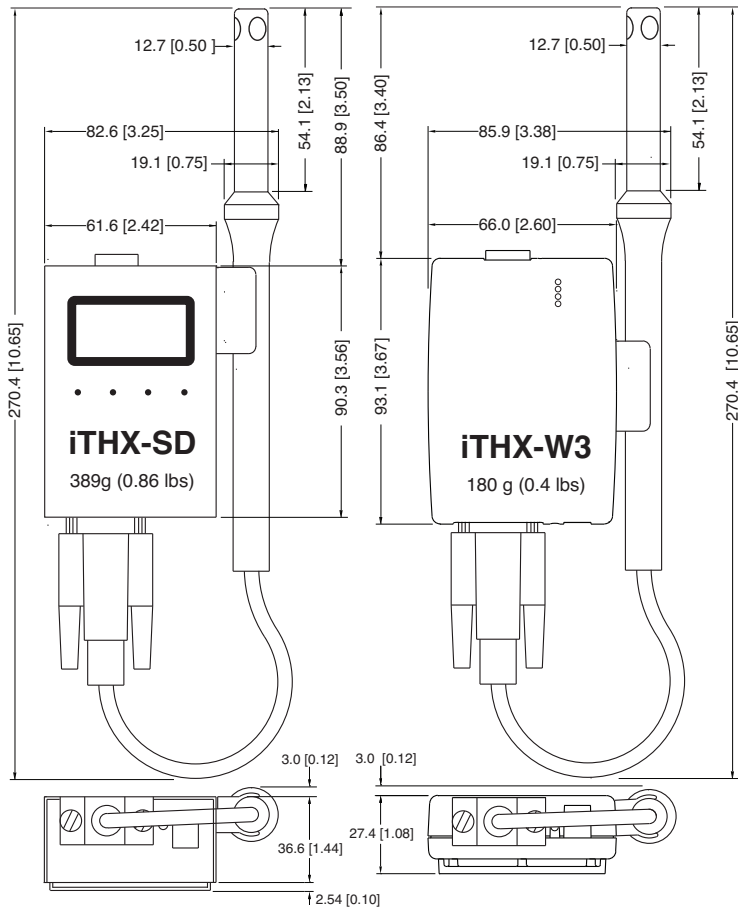

**iDRN-PS-1000**

- 24Vdc Supply
- Mounts to 35mm DIN rails
- Switching Power Supply powers up to 7 units

**iP-PCW**

One Porous Polyethylene Cap **iP-PCI** or **iP-PCW** is included with each probe.

An optional Porous Stainless Steel Cap **iP-SC** is available for industrial probes.

**iP-PCI**      **iP-SC**      **Standard**

| Model No.        | Description  |
|------------------|--|
| <b>iTHX-SD</b>   | iServer MicroServer™ for temperature + humidity and dewpoint, LCD Display, 2GB SD flash memory card, 2 relay alarm, battery back-up, commercial wand probe on 152 mm (6") cable with DB9 connector |
| <b>iTHX-SD-2</b> | iServer MicroServer™ with LCD display, industrial 51 mm (2") probe on 0.9 m (3 ft) cable with DB9 connector  |
| <b>iTHX-SD-5</b> | iServer MicroServer™ with LCD display, industrial 137 mm (5") probe on 3 m (10 ft) cable with DB9 connector  |
| <b>iTHX-W3</b>   | iServer MicroServer™ for temperature + humidity and dew Point, commercial wand probe on 152 mm (6") cable with DB9 conn.   |
| <b>iTHX-W3-2</b> | iServer MicroServer™ with industrial 51 mm (2") probe on 0.9 m (3 ft) cable with DB9 connector   |
| <b>iTHX-W3-5</b> | iServer MicroServer™ with industrial 137 mm (5") probe on 3 m (10 ft) cable with DB9 connector   |
| <b>iTHX-D3</b>   | DIN rail case iServer MicroServer™ for temperature + humidity and dew point, with industrial 137 mm (5") probe on 3 m (10 ft) cable with stripped wire leads                                       |
| <b>iTHX-D3-2</b> | DIN rail case iServer MicroServer™ for temperature + humidity and dew Point, with industrial 51 mm (2") probe on 0.9 m (3 ft) cable with stripped wire leads                                       |

| Accessories           |   |
|-----------------------|---|
| <b>DB9-CA-3</b>       | Extension cable, 0.9 m (3 ft) with DB9 connector  |
| <b>iDRN-PS-1000</b>   | Power supply (switching), 95 to 240 Vac input, 24 Vdc output @ 850 mA (powers up to 7 units)          |
| <b>RAIL-35-2</b>      | 2 m (6.5 ft) section of 35mm DIN rail   |
| <b>iP-PCI-10P</b>     | Porous polyethylene industrial probe cap, for wet environments, 10 caps per pack                      |
| <b>iP-PCW-10P</b>     | Porous polyethylene commercial wand probe cap, for wet environments, 10 caps per pack                 |
| <b>iP-SC</b>          | Porous stainless steel probe cap, 5um porosity, for dusty and pressurized (< 35 psi) environments     |
| <b>CAL-3-HU</b>       | NIST traceable calibration certificate. 3 points of 25%, 50%, 75% RH, temperature 25°C, for new units |
| <b>CT485B-CAL-KIT</b> | Calibration kit, 33% and 75% RH standards   |

| Replacement Probes and Calibrated Replacement Probes |  |
|--|--|
| <b>iTHP-W-6</b>                                      | Replacement commercial wand probe, cable 152 mm (6") with DB9 connector, for iTHX-SD/-W3             |
| <b>iTHP-2-DB9</b>                                    | Replacement industrial 51 mm (2") probe, cable 0.9 m (3 ft) with DB9 connector, for iTHX-SD/-W3 *1   |
| <b>iTHP-5-DB9</b>                                    | Replacement industrial 137 mm (5") probe, cable 3 m (10 ft) with DB9 connector, for iTHX-SD/-W3 *1   |
| <b>iTHP-2</b>  | Replacement industrial 51 mm (2") probe, cable 0.9 m (3 ft) with stripped wire leads, for iTHX-D3 *1 |
| <b>iTHP-5</b>  | Replacement industrial 137 mm (5") probe, cable 3 m (10 ft) with stripped wire leads, for iTHX-D3 *1 |
| <b>-CAL-3-HU</b>                                     | Any of the above replacement probes with calibration certificate                                     |

**Ordering Examples** for iTHX-SD with LCD display, SD card, 2 relay alarm, battery back-up and wand probe: **iTHX-SD**.  
 For iTHX-W3 with substitution of industrial 5" probe and 10' cable: **iTHX-W3-5**.  
 For iTHX-D3 and switching power supply: **iTHX-D3 + iDRN-PS-1000**.  
 For calibrated replacement probe, with certificate: **iTHP-W-6-CAL-3-HU**.  
 \*1 Other lengths of cable (up to 40 ft) are available, please contact our Sales Department. \* Volume discounts are available.