

CE

iServer

Embedded Ethernet Server for iSeries Monitor/Controller

Operator's Manual



NEWPORT Electronics, Inc.
<http://www.newportUS.com/iServer>

Additional products from

NEWPORT Electronics, Inc.

Counters	Rate Meters
Frequency Meters	Timers
PID Controllers	Totalizers
Clock/Timers	Strain Gauge Meters
Printers	Voltmeters
Process Meters	Multimeters
On/Off Controllers	Soldering Iron Testers
Recorders	pH pens
Relative Humidity	pH Controllers
Transmitters	pH Electrodes
Thermocouples	RTDs
Thermistors	Thermowells
Wire	Flow Sensors

For Immediate Assistance
In the U.S.A. and Canada: 1-800-NEWPORT[®]
In Mexico: (95) 800-NEWPORTSM
Or call your local NEWPORT Office.

NEWPORTnetSM On-Line Service
www.newportUS.com

Internet e-mail
info@newportUS.com

It is the policy of NEWPORT to comply with all worldwide safety and EMC/EMI regulations that apply. NEWPORT is constantly pursuing certification of its products to the European New Approach Directives. NEWPORT will add the CE mark to every appropriate device upon certification.

The information contained in this document is believed to be correct but NEWPORT Electronics, Inc. accepts no liability for any errors it contains, and reserves the right to alter specifications without notice.

WARNING: These products are not designed for use in, and should not be used for, patient connected applications.

TRADEMARK NOTICE: ,  **NEWPORT**, **NEWPORT[®]** and **newportUS.com** are trademarks of NEWPORT Electronics, Inc.

PATENT NOTICE: This product is covered by one or more of the following patents: U.S. Pat. No. Des. 336,895; 5,274,577/ CANADA 2052599; 2052600/ ITALY 1249456; 1250938 / FRANCE BREVET No. 91 12756 / SPAIN 2039150; 2048066 / UK PATENT No. GB2 249 837; GB2 248 954 / GERMANY DE 41 34398 C2. The  is a Trademark of OMEGA Engineering, Inc. Used Under License. Other US and International Patents pending or applied for.



This device is marked with the international caution symbol. It is important to read the Setup Guide before installing or commissioning this device as it contains important information relating to safety and EMC.

TABLE OF CONTENTS

Part 1: Introduction		
1.1	Safety and EMC Considerations	2
1.2	Description	3
Part 2: Hardware		
2.1	Physical Characteristics and Mounting	4
2.2	Rear Panel of iSeries Meter with Embedded Ethernet Server	4
2.3	DIP Switches on the iServer	5
2.4	Serial Communication Interfaces (For Models with RS485 Port)	6
2.4.1	Wiring RS485 Interface	7
2.5	Network Communication Interfaces	8
2.5.1	10Base-T RJ-45 Pinout	8
2.5.2	10Base-T Crossover Wiring	8
Part 3: Network Configuration		
3.1	Network Protocols	9
3.2	Ethernet (MAC) Address	9
3.3	DHCP	10
3.4	DNS	10
3.5	IP Address	11
3.5.1	Default IP Address	11
3.6	Port Number	11
Part 4: Operations		
4.1	Serial Interface Configuration-Communication Protocol	12
4.2	Command Structure	12
4.3	Command Formats	12
4.4	Operations	14
4.5	Setup and Operation using a Web Browser	14
4.5.1	Read Devices	16
4.5.1.1	Device Setpoints	16
4.5.2	Send Raw Command	16
4.5.3	Device Setup	17
4.5.3.1	Modify Device Parameters (or Device List Entry)	17
4.5.4	Configuration	18
4.5.5	Access Control	21
4.6	Setting a New IP Address over the Network	23
4.7	Terminal Server Function	24
4.8	Terminal Emulation	25
4.9	Telnet Setup	26
4.10	HTTPGET Program	28
4.11	ARP Protocol	29
4.12	Remote Access (Tunneling)	30
4.12.1	Remote iServer	31
4.12.2	Local iServer	32
4.13	Mail Notifier Software	33
4.13.1	Installation	33
4.13.2	Program Options Setup and Configuration	34
4.13.3	Device Setting Setup and Configuration	35
Part 5: Specifications		36
Part 6: Factory Preset Values		37
Appendix A	Glossary	38
Appendix B	IP Address	39
Appendix C	IP Netmask	40
Appendix D	ASCII Chart	41
	ASCII Chart Control Codes	42
Part 7: Approvals Information		
7.1	Electromagnetic Compatibility (EMC)	43
7.2	FCC	43

LIST OF FIGURES:

Figure 1.1	iServer on the Ethernet Network.....	3
Figure 2.1	Rear Panel View of i16 and i8 Series Meters with Embedded Ethernet Server	4
Figure 2.2	DIP Switches on the iServer	5
Figure 2.3	Multi-point, Half-Duplex RS485 Wiring	7
Figure 2.4	RJ45 Pinout	8
Figure 2.5	10Base-T Crossover Cable Wiring	8
Figure 3.1	i8 - Labeling	9
Figure 3.2	i16 - Labeling	9
Figure 3.3	DIP Switch on the iServer	10
Figure 4.1	Pinging eis03ec MS-DOS Prompt	14
Figure 4.2	Device Type	15
Figure 4.3	iServer Home Page Menu	15
Figure 4.4	Login and Administrator Password	15
Figure 4.5	Read Devices	16
Figure 4.6	Device Setpoints	16
Figure 4.7	Serial Device Query	16
Figure 4.8	Device Setup	17
Figure 4.9	Modify Device Parameters	17
Figure 4.10	Configuration	18
Figure 4.11	Access Control	21
Figure 4.12	Access Control	23
Figure 4.13	Terminal Server Configuration	24
Figure 4.14	Terminal Emulation	25
Figure 4.15	Tera Term Telnet Connection Screen	26
Figure 4.16	Telnet Setup Menu - iServer Configuration Page	26
Figure 4.17	Telnet Setup Menu - iServer Help Page	27
Figure 4.18	ARP Commands and Responses	29
Figure 4.19	PC-to-Device Communication.....	30
Figure 4.20	Device-to-Device Communication	30
Figure 4.21	Configuration Menu - Remote iServer.....	31
Figure 4.22	Configuration Menu - Local iServer.....	32
Figure 4.23	iServer Mail Notifier Main Window.....	33
Figure 4.24	iServer Mail Notifier Profile Setup	34
Figure 4.25	iServer Mail Notifier Device Setting	35

LIST OF TABLES:

Table 2.1	Rear Panel Annunciators	5
Table 2.2	Data Transmission Characteristics RS485	6
Table 2.3	RS485 Half-Duplex Hookup.....	7
Table 4.1	Command Prefix Letters	12
Table 4.2	Command Formats	12

NOTES, WARNINGS and CAUTIONS

Information that is especially important to note is identified by following labels:

- **NOTE**
- **WARNING or CAUTION**
- **IMPORTANT**
- **TIP**

 **Note**

NOTE: Provides you with information that is important to successfully setup and use the iServer.



CAUTION or WARNING: Tells you about the risk of electrical shock.



CAUTION, WARNING or IMPORTANT: Tells you of circumstances or practices that can effect the instrument's functionality and must refer to accompanying documents.

 **Tip**

TIP: Provides you helpful hints.

Before You Begin

Inspecting Your Shipment:

Remove the packing slip and verify that you have received everything listed. Inspect the container and equipment for signs of damage as soon as you receive the shipment. Note any evidence of rough handling in transit. Immediately report any damage to the shipping agent. The carrier will not honor damage claims unless all shipping material is saved for inspection. After examining and removing the contents, save the packing material and carton in the event reshipment is necessary.

Customer Service:

If you need assistance, please contact the Customer Service Department nearest you.

Manuals, Software:

The latest Operation Manual as well as free iSeries configuration software and iServer Mail Notifier are available at **the website listed on the cover page of this manual or on the CD-ROM enclosed with your shipment.**

PART 1 INTRODUCTION

1.1 Safety and EMC Considerations



This device is marked with the international caution symbol. It is important to read this manual before installing or commissioning this device as it contains important information relating to Safety and EMC (Electromagnetic Compatibility).

This instrument is a panel mount device protected in accordance with EN 61010-1:2001, electrical safety requirements for electrical equipment for measurement, control and laboratory. Installation of this instrument should be done by qualified personnel. In order to ensure safe operation, the following instructions should be followed.



This instrument has no power-on switch. An external switch or circuit-breaker shall be included in the building installation as a disconnecting device. It shall be marked to indicate this function, and it shall be in close proximity to the equipment within easy reach of the operator. The switch or circuit-breaker shall meet the relevant requirements of IEC 947-1 and IEC 947-3 (International Electrotechnical Commission). The switch shall not be incorporated in the main supply cord.



Furthermore, to provide protection against **excessive energy** being drawn from the main supply in case of a fault in the equipment, an **overcurrent** protection device shall be installed.



- Do not exceed voltage rating on the label located on the top of the instrument housing.
- Always disconnect power before changing signal and power connections.
- Do not use this instrument on a work bench without its case for safety reasons.
- Do not operate this instrument in flammable or explosive atmospheres.
- Do not expose this instrument to rain or moisture.
- Unit mounting should allow for adequate ventilation to ensure instrument does not exceed operating temperature rating.
- Use electrical wires with adequate size to handle mechanical strain and power requirements. Install without exposing bare wire outside the connector to minimize electrical shock hazards.

EMC Considerations

- Whenever EMC is an issue, always use shielded cables.
- Never run signal and power wires in the same conduit.
- Use signal wire connections with twisted-pair cables.
- Install Ferrite Bead(s) on signal wires close to the instrument if EMC problems persist.

Failure to follow all instructions and warnings may result in injury!

1.2 Description

Note

This iServer board can be purchased as a stand alone unit, or as an option for an iSeries monitor/controller (Embedded Ethernet iServer) with a RS485 communication port interface. Some iSeries monitors/controllers do not utilize RS485 communications. In such models, the RS485 instructions do not apply.

The Embedded Ethernet Server is designed to connect industrial devices with serial interfaces to the Ethernet network using the TCP/IP protocol. It contains an Ethernet Server and RS-485/422 interfaces.

The standard features include:

- Use standard Web Browser, TCP connection, HTTPGET DOS program or Telnet Simulation for network connectivity.
- Install via RS-485/422 serial port connection.
- Transfer data from RS-485/422 serial interface to TCP/IP using built-in socket server.
- Use a standard home page or customize web page using special applets, which are available on our Web site.

The following example illustrates how you can hookup the devices with serial interface on the net using the Ethernet Server:

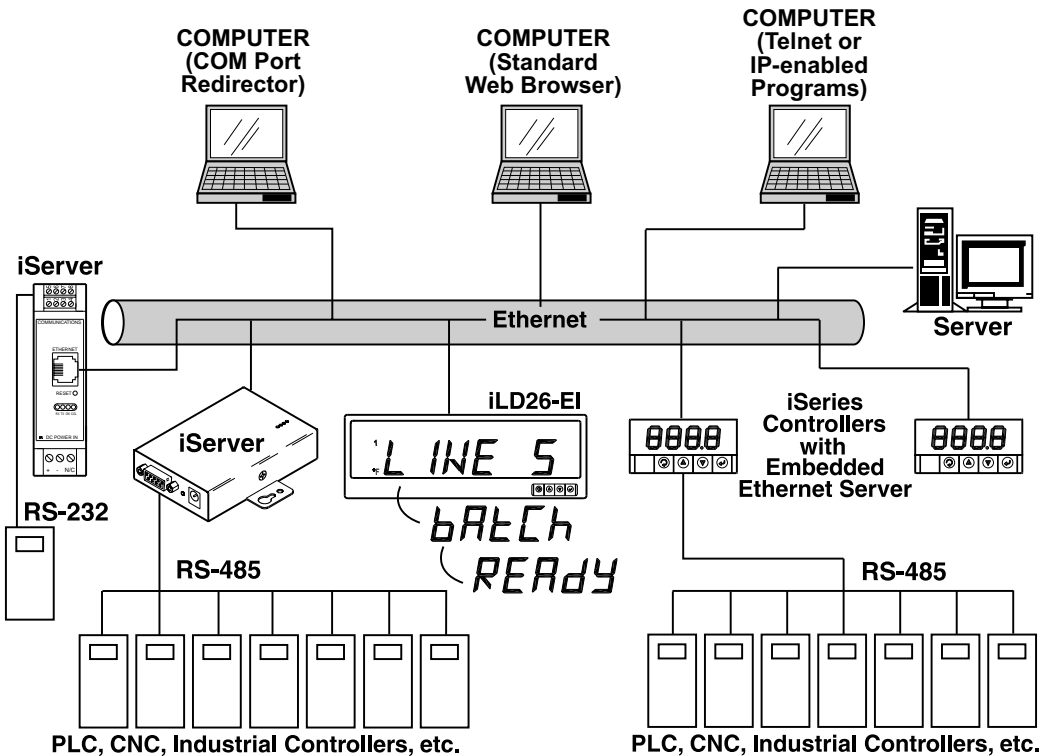

Figure 1.1 iServer on the Ethernet Network

**PART 2
HARDWARE**

2.1 Physical Characteristics and Mounting

For physical dimensions and installation instructions see Quickstart and Manual for iSeries monitor/controller.

2.2 Rear Panel of iSeries Meter with Embedded Ethernet Server

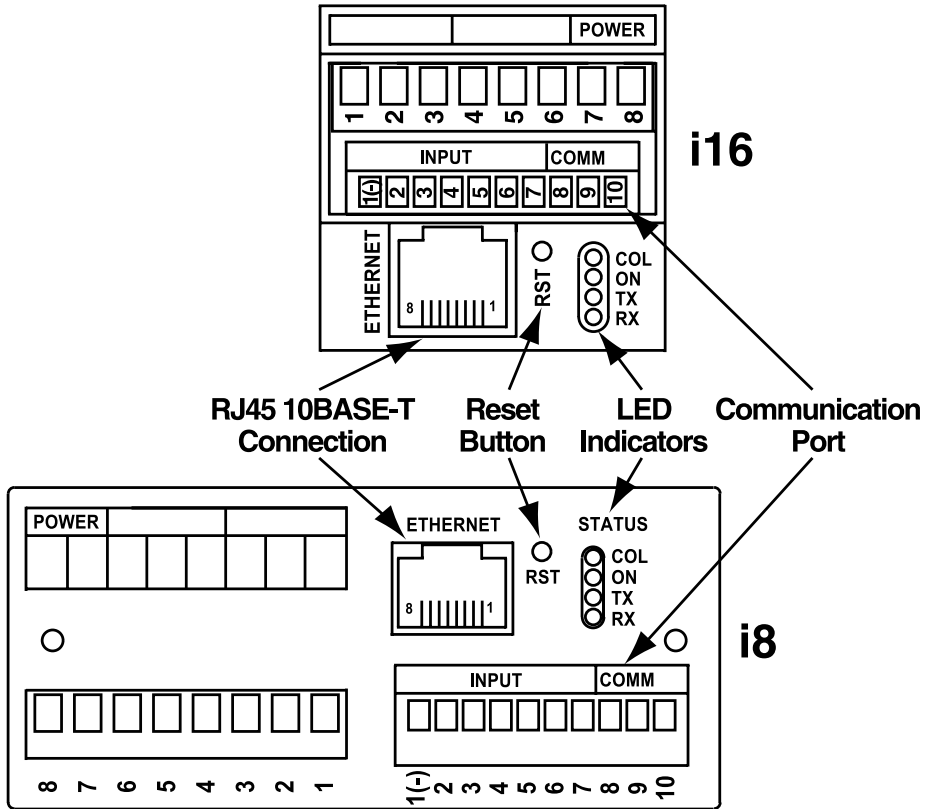
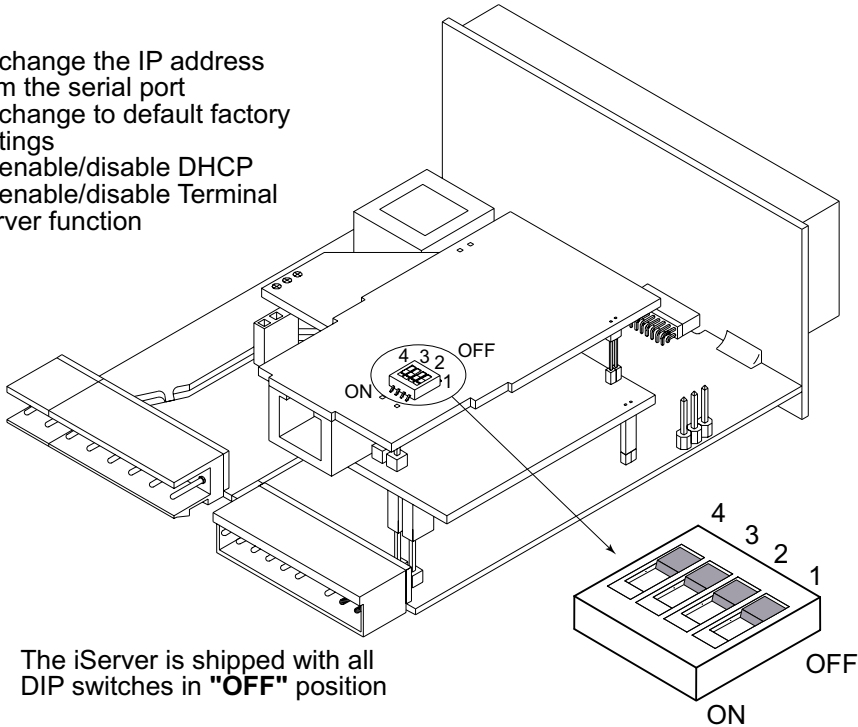

Figure 2.1 Rear Panel View of i16 and i8 Series Meters with Embedded Ethernet Server

2.3 DIP Switches on the iServer

For Dipswitch access you must remove the main board from the case. Refer to the Disassembly Instructions in your iSeries Monitor/Controller Quickstart Manual.

- 1 To change the IP address from the serial port
- 2 To change to default factory settings
- 3 To enable/disable DHCP
- 4 To enable/disable Terminal Server function



Note The iServer is shipped with all DIP switches in "OFF" position

Figure 2.2 DIP Switches on the iServer

Table 2.1 Rear Panel Annunciators

Serial Communication Interface Section (For Models with RS485):	
Pin 10	-Rx/Tx
Pin 9	+Rx/Tx
Pin 8	Return, Common Ground Shield connection
Network Communication Interface Section:	
ETHERNET	RJ45 interface for 10BASE-T connection.
RESET	Button: Used for power resetting the iServer.
COL / ACTIVITY	LED (Red) Blinking: Indicates network activities (receiving or sending packets).
ON / NET LINK	LED (Green) Solid: Indicates good network link.
TX	LED (Yellow) Blinking: Indicates transmitting data to the serial port.
RX	LED (Green) Blinking: Indicates receiving data on the serial port.

2.4 Serial Communication Interfaces (For Models with RS485 Port)

The iSeries controller/monitor with the Embedded Ethernet Server option board support only RS485/422 interfaces. These standards define the electrical characteristics of a communication network. The RS485 port of the Ethernet Server is fully compatible for use with RS422 instruments. The RS485 is an extended version of the RS422 communication standard which increases the allowable number of devices from 10 to 32 by improving the electrical characteristics.

- The **RS485** standard (**multi-point**) allows one or more devices (multi-dropped) to be connected to the Ethernet Server using a two-wire connection (half-duplex) +Rx/+Tx and -Rx/-Tx. Use of RS485 communications allows up to 32 devices to connect to the Web Server with cable length up to 4000 feet long.

Note

Although the RS485 is commonly referred to as a "two wire" connection, the Web Server also provides a ground/return shield connection to use as a common connection for EMI noise protection.

Table 2.2 shows some characteristics of the RS485 communication interface.

Table 2.2 Data Transmission Characteristics RS485

Data Transmission Characteristics	RS485
Transmission Mode	Differential
Electrical connections	2 wire
Drivers per line	32 drivers
Receivers per line	32 receiver
Maximum data rate	10M bits/s
Maximum cable length	4000 ft (1200 meters)

2.4.1 Wiring RS485 Interface

RS485 interface uses a two-wire communication system (one for transmitting and one for receiving) plus a common wire to connect to the shield of the cable. It is recommended to use a shielded cable with one twisted pair.

Note ES[®] Use of twisted pair and shield will significantly improve noise immunity.

Figure 2.3 shows multi-point, half-duplex RS485 interface connections for the iServer.

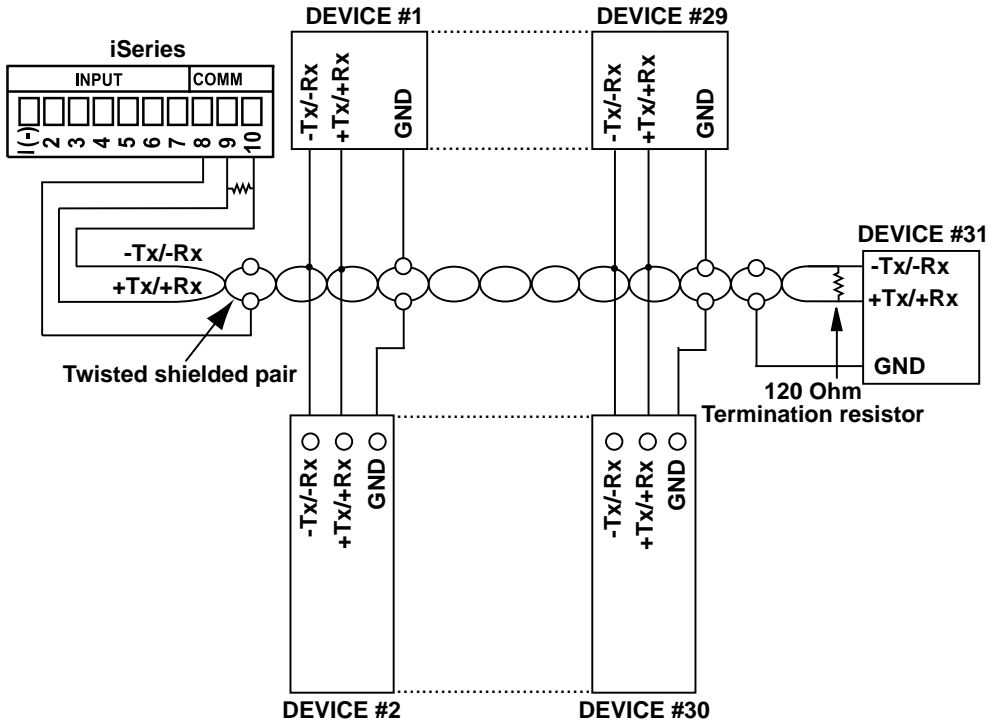

Figure 2.3 Multi-point, Half-Duplex RS485 Wiring

Note ES[®] Value of the termination resistor is not critical and depends on the cable impedance.

Table 2.3 shows RS485 half-duplex hookup between the iServer serial port and device with RS485 communication interface.

Table 2.3 Half Duplex Hookup

Pin#	iSeries	DEVICE # WITH RS485
Pin 9	+Tx/+Rx (+Transmit/+Receive)	+Tx/+Rx (+Transmit/+Receive)
Pin 10	-Tx/-Rx (-Transmit/-Receive)	-Tx/-Rx (-Transmit/-Receive)
Pin 8	RTN (Common GND)	GND (Common GND)

PART 3 NETWORK CONFIGURATION

3.1 Network Protocols

The iServer can be connected to the network using standard TCP/IP protocols. It also supports ARP, HTTP (WEB server), DHCP, DNS and Telnet protocols.

3.2 Ethernet (MAC) Address

MAC (Media Access Control) address is your computer's unique hardware number. When you're connected to the LAN from your computer, a correspondence table relates your IP address to your computer's physical (MAC) address. The MAC address can be found on the label of your device and contains 6 bytes (12 characters) of hexadecimal numbers XX:XX:XX:XX:XX:XX hex

For example: 0A:0C:3D:0B:0A:0B



Remove the small label with the default IP address and there will be room to put your IP address. See **Figure 3.1** and **Figure 3.2**.

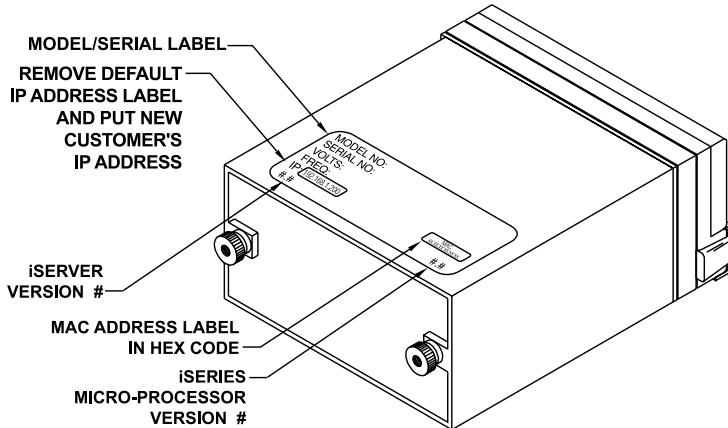

Figure 3.1 i8 - Labeling

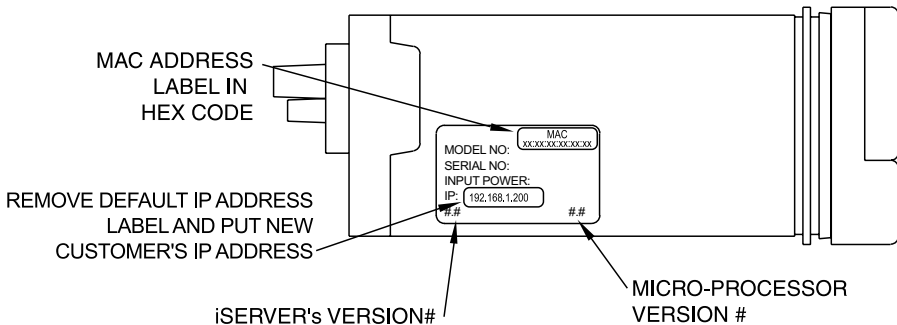

Figure 3.2 i16 - Labeling

3.3 DHCP

DHCP, Dynamic Host Configuration Protocol enables individual computers or devices to extract their IP configurations from a server (DHCP server). If the DHCP is enabled on your iServer, as soon as the iServer is connected to the network, there is an exchange of information between DHCP server and the iServer. During this process the IP address, the Gateway address, and the Subnet Mask will be assigned to the iServer by the DHCP server. Note that the DHCP server must be configured correctly to do such assignment.

If fixed or static IP address is desired, the DHCP must be disabled. The iServer is shipped with DHCP disabled (factory default). The DHCP can be enabled by setting the DIP switch # 3 to the “ON” position (refer to **Figure 3.3**).

Note 

DIP switch # 3 shown in “ON” position

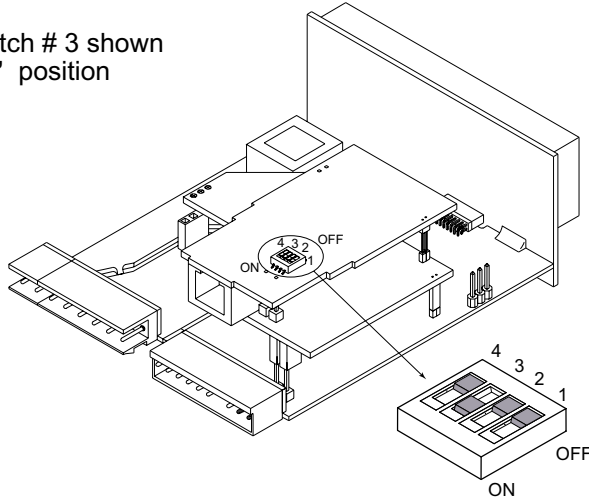

Figure 3.3 DIP Switch on the iServer

3.4 DNS

DNS, Domain Name System enables individual computers and devices to be recognized over a network based on a specific name instead of an IP address. For example, instead of having to use **http://192.168.1.200** (IP address), you would use only **http://eis03ec** or any eight character name stored as Host Name under Access Control menu in the iServer Home Page. The default DNS name for an iServer is “eis” followed by the last four digits of the MAC address of that particular iServer.

Note 

1. It is very important to communicate with the network administrator in order to understand the DHCP and its existing configurations on the host server, before enabling the DHCP on the iServer.
2. The iServers are shipped with a default static IP address of **192.168.1.200** and Subnet Mask of **255.255.255.0**.
3. On Novell networks or Windows 2000 where the DCHP is an updated function of DNS this feature may be beneficial since a particular name can be assigned eliminating the need for the IP address, as described in **Section 3.4**.

3.5 IP Address

Every active device connected to the TCP/IP network must have a unique IP address. This IP address is used to build a connection to the iServer's serial port. Every computer using TCP/IP should have a unique 32-bit address. It is divided into two portions, the network ID and the host ID. For instance, every computer on the same network uses the same network ID. At the same time, all of them have a different host ID. For more details about the IP address see **Appendix B**.

3.5.1 Default IP Address

The iServer is shipped with a default IP address set to **192.168.1.200** and Subnet Mask of **255.255.255.0**. If you are going to use a Web browser or Telnet program to access the iServer using its default IP address, make sure that the PC from which you're establishing the connection has an IP address that is in the same range as the iServer's IP address (**192.168.1.x**, where **x** can be any number from 1 to 254).

Note

Your PC's IP address cannot be the same as the iServer's IP address).

You also need to make sure that your PC's Subnet Mask is **255.255.255.0**. This is a good way to access the iServer over the network and make any configuration changes needed. If the factory default address is already in use on your network, use an Ethernet crossover cable between your computer and the iServer and modify the IP address or any other settings within the iServer.

3.6 Port Number

All TCP connections are defined by the IP address and a port number. A port number is an internal address that provides an interface between an application running on your computer and the network through the TCP/IP protocol.

There are three default TCP socket port numbers assigned to the iServer:

1. Port (socket) number 1000 when using HTTPGET program.
2. Port (socket) number 2000 when trying to access your serial device connected to the serial port of the iServer.
3. Port (socket) number 2002 when trying to access the iServer itself for reading or changing the settings. This can be done using Telnet application.

Example: C:\>Telnet **192.168.1.200 2002**

PART 4 OPERATIONS

An industrial device with serial interfaces (PLC, CNC controllers, PC, Data Display Devices, etc.) can be connected to the serial port of the Web Server.

4.1 SERIAL INTERFACE CONFIGURATION - Communication Protocol

A data communication protocol defines the rules and structure of messages used by all devices on a network for data exchange. A typical transaction will consist of a request to send from the MASTER followed by the response from one or more SLAVE devices. Either a single (point-to-point) or multi-drop network (multi-point) is possible.

4.2 Command Structure

There are different command types associated with communication between the Ethernet Server and your device shown in **Table 4.1**, which shows the Command Prefix Letters (Command Classes)

Table 4.1 Command Prefix Letters

COMMAND PREFIX (COMMAND CLASS)	MEANING
^AE	Special read, Communication parameters
P (Put)	Write HEX data into RAM
W (Write)	Write HEX data into EEPROM.
G (Get)	Read HEX data from RAM
R (Read)	Read HEX data from EEPROM
U	Read status byte
V	Read measurement data string in decimal format
X	Read measurement data values in decimal format
D	Disable
E	Enable
Z	Reset

4.3 Command Formats

Table 4.2 shows the command formats for the Ethernet Server.

Table 4.2 Command Formats

For "P" and "W" Command classes:	For "G" and "R" Command classes:	For "X", "V", "U", "D", "E", & "Z" Command classes:
Point-to-point mode * ccc<data><cr>	Point-to-point mode * ccc <cr>	Point-to-point mode * ccc <cr>
Multi-point mode * ncccc [<data>]<cr>	Multi-point mode * ncccc <cr>	Multi-point mode * ncccc <cr>

Where:

"*" is the selected Recognition Character. You may select any ASCII table symbol from "!" (HEX address "21") to the right-hand brace (HEX "7D") except for the caret "^", "A", "E", which are reserved for bus format request.

"ccc" stands for the hex-ASCII Command Class letter (one of eleven given in Table 4.1), followed by the two hex-ASCII Command Suffix characters identifying the meter data, features, or menu items to which the command is directed.

"<data>" is the string of characters containing the variable information the computer is sending to the meter. These data (whether BCD or binary) are encoded into hex-ASCII character (see Appendix D for binary-hex-ASCII chart), two characters to the byte. Square brackets [indicating optional status] enclose this string, since some commands contain no data.

"<nn>" are the two ASCII characters for the device Bus Address of RS485 communication. Use values from "00" to hex "C7" (199 decimal).

The following format is used for each byte sent and received through serial port of Ethernet Server:

1. Seven or Eight-bit binary, Hexadecimal (0 ... 9, A ... F)
2. Two hexadecimal characters contained in each eight-bit field of the message
3. 1 start bit; 7 or 8 data bit; 1 Stop Bit; Odd, Even (No Parity) Bit

The figure below shows the bit sequences when a byte is transmitted or received through the Ethernet Server.

LSB							MSB			
START	1	2	3	4	5	6	7	8	STOP	PARITY

LSB – Least Significant bit

MSB – Most Significant bit

Least Significant beat sent first

4.4 OPERATIONS

This iServer can be used and configured in several ways, depending on user's preference and network setup. It can be used in Telnet simulation mode where it emulates serial communication operation over a network cable or directly from a Web browser, like Netscape or Internet Explorer.

If DHCP and DNS servers are used, the connection is very simple, you do not need to worry about IP address, MAC address, or network conflicts, all of these issues are solved for you by your network DHCP and DNS server. All that is left for you to do, is to use a straight/normal network cable to connect the device to a hub and power it up. Then you can go to your computer that is connected over the same network and from the MS-DOS Prompt window type "**ping eisxxxx**" followed by the last four digits from the MAC address located on the side or back of the device.

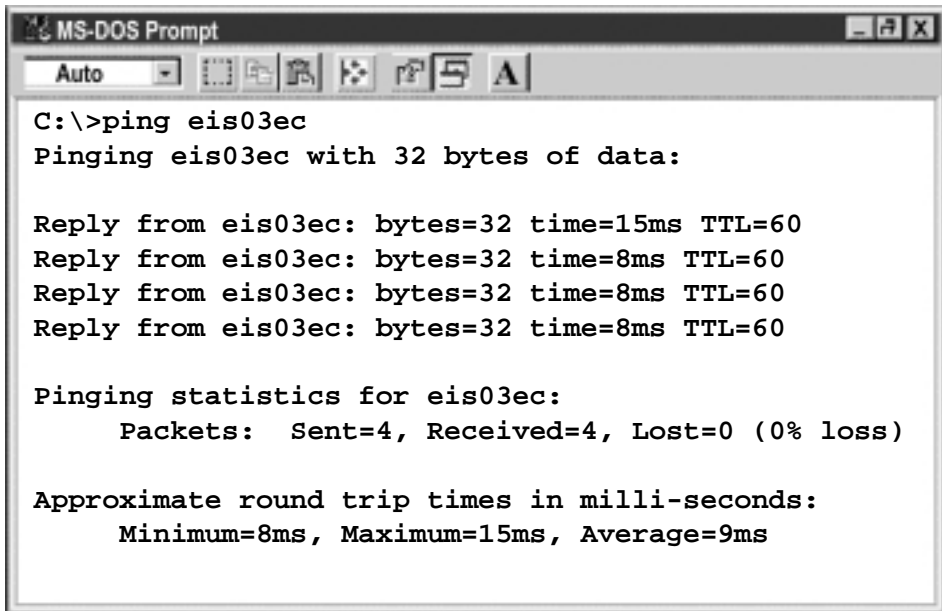

```
MS-DOS Prompt
Auto
C:\>ping eis03ec
Pinging eis03ec with 32 bytes of data:

Reply from eis03ec: bytes=32 time=15ms TTL=60
Reply from eis03ec: bytes=32 time=8ms TTL=60
Reply from eis03ec: bytes=32 time=8ms TTL=60
Reply from eis03ec: bytes=32 time=8ms TTL=60

Pinging statistics for eis03ec:
    Packets: Sent=4, Received=4, Lost=0 (0% loss)

Approximate round trip times in milli-seconds:
    Minimum=8ms, Maximum=15ms, Average=9ms
```

Figure 4.1 Pinging eis03ec MS-DOS Prompt

This proves that the connection is proper and you can get into configuration or run mode using the Telnet or Web browser.

4.5 Setup and Operation Using a Web Browser

- Start your web browser.
- From the browser you type <http://eisxxxx> using the last four-digits from the MAC address label located on the device if DHCP and DNS are used. If a static IP address is used, then simply type <http://x.x.x.x>, where **x.x.x.x** is the iServer's IP address.
- The Home Page, shown below, will be displayed.
- From the drop-down window you can select the type of device connected (iSeries, iDRN, iDRX, iR2, INFB, or iLD) then press Update to get to the Home Page.

4.5 Setup and Operation Using a Web Browser (continued)

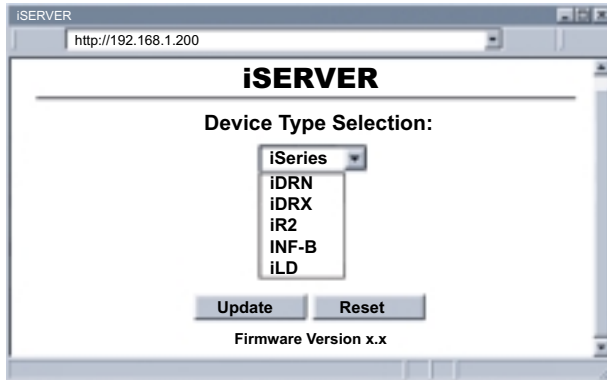

Figure 4.2 Device Type



Figure 4.3 iServer Home Page Menu

In order to access certain menu items of the iServer Home Page, users may be prompted for a Login Password.

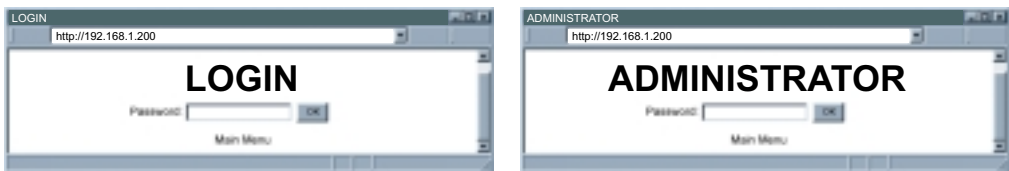

Figure 4.4 Login and Administrator Passwords

Login Password: This allows users to access and modify all of the iServer Home Page menu items, except "Access Control", which requires an Administrator password (refer to **Section 4.5.5**). The "Read Devices" does not require a password.

The default Login password is **12345678**. This password can be up to 16 alpha-numeric case-sensitive characters.

4.5.1 Read Devices

- Read variables from up to eight different devices.
- Read up to eight variables from the same device.
- Read and write the setpoint values to the device.

If you have 000, click the Auto Update button to manually refresh the page. If you want to change the time interval of the page refresh, enter the amount of seconds in the box.

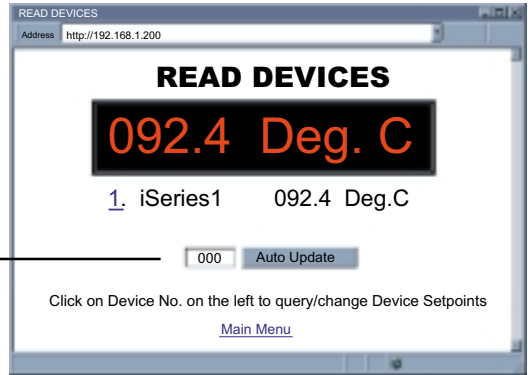

Figure 4.5 Read Devices

4.5.1.1 Device Setpoints

- When you click on Device No in the Read Device Page, you can edit the Setpoints.

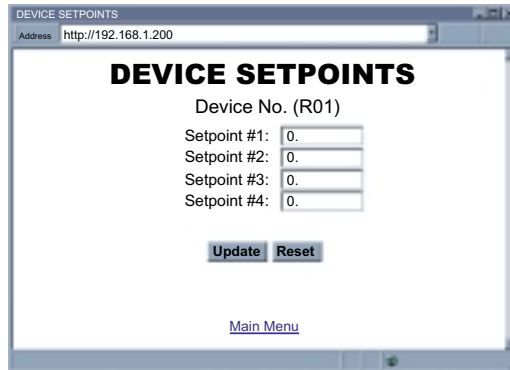

Figure 4.6 Device Setpoints

4.5.2 Send Raw Command

- Send single command and receive response.

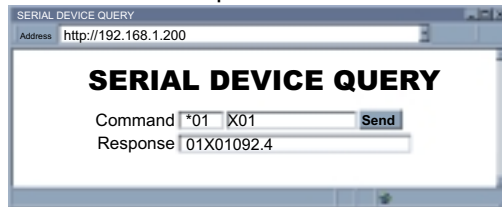

Figure 4.7 Serial Device Query

4.5.3 Device Setup

- Device Setup helps you to see eight different variables or devices by “Check” box.
- Up to four different devices or parameters can be modified.
- Device Address or ID is in Hex format. See **Appendix D** for conversion.

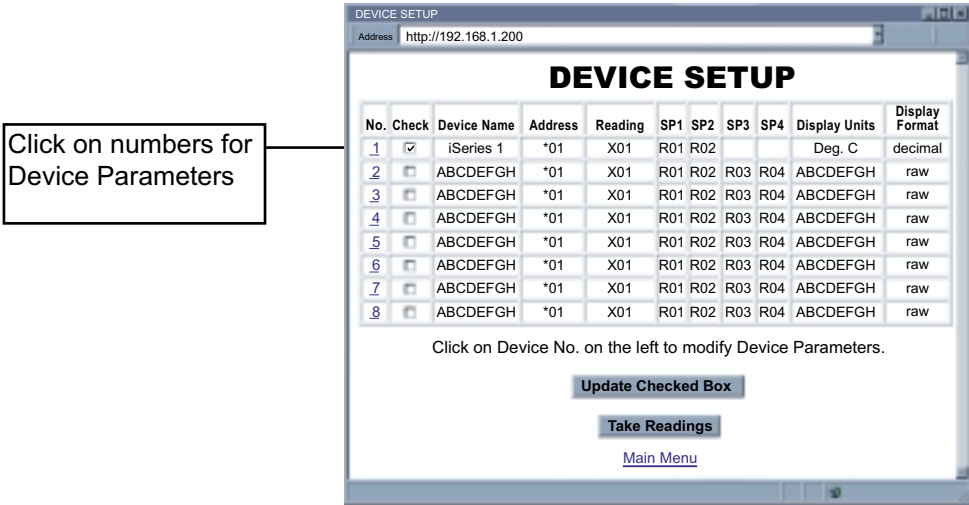

Figure 4.8 Device Setup

4.5.3.1 Modify Device Parameters (or Device List Entry)

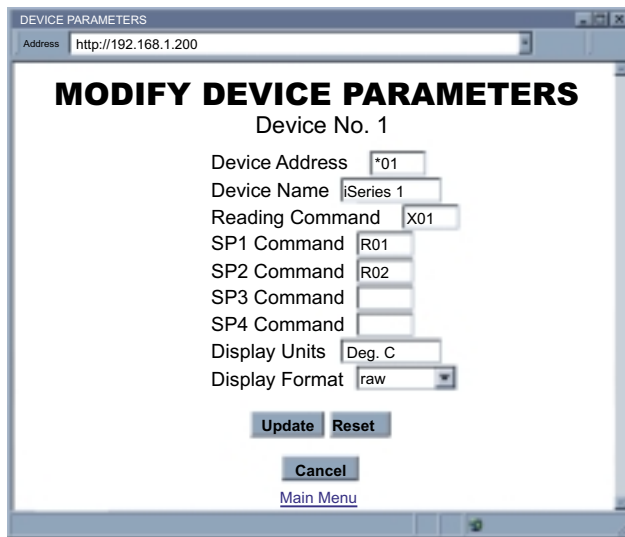

Figure 4.9 Modify Device Parameters

4.5.4 Configuration

- This section explains the Configuration page of the iServer's Web interface.
- When connecting your device to the iServer, the Serial Communications parameters must match, between the iServer and your serial device.

The screenshot shows a web browser window titled 'CONFIGURATION' with the address 'http://192.168.1.200'. The page content is divided into three sections, each marked with a letter on the left:

- A** **Serial Communication**
 - Baud Rate: 9600
 - Data Bit: 7 Bits
 - Parity: odd
 - Stop Bits: 1 bit
 - Flow Control: none
 - Transceiver: RS-485
 - Modbus/TCP: disable
 - End Character (Hex): 0D
 - Forward End Char: enable
 - Timeout: 0500 msec
 - Serial Port Password: disable, 1234abcd
- B** **Terminal Server**
 - TCP/UDP: TCP
 - Server Type: slave
 - Number of Connections: 0
 - Local Port: 02000
 - Connection Ctrl: not used
 - Device No.: 1
 - Connection Timeout: 00100 msec
- C** **Remote Access (Tunneling)**
 - Remote Access: disable
 - Remote IP Address: 0.0.0.0
 - Remote Port: 02000

At the bottom of the configuration page are buttons for 'Save', 'Reset', and a link for 'Main Menu'.

Figure 4.10 Configuration

4.5.4.A Serial Communication

Baud Rate: The speed on the serial port and can be set from 300 to 115,200 bits/s (default is 9600 bits/s.)

Data Bit: Options are 7 or 8 (default is 7 bits.)

Parity: Options are Odd, Even, and None (default is Odd.)

Stop Bits: Options are 1 and 2 bits (default is 1 bit.)

Flow Control: Options are Software Flow Control (Xon/Xoff), Hardware Flow Control (CTS/RTS), and None (default is None.)

4.5.4.A Serial Communication (continued)

Transceiver: Can either be set to RS-232 or two-wire RS-485 (default is RS-485.)

Modbus/TCP: A widely used protocol mainly in industrial automation applications with default TCP port number of 502 (see Local Port field). The options are Enable and Disable. If enabled, the Modbus/TCP is the only protocol driven by the iServer on its LAN port. If disabled, the TCP/IP is the only protocol driven by the iServer on its LAN port (default is disable).

End Character: When the defined Hex character is received by the iServer on its serial port, the iServer will forward the buffered serial data to the Ethernet. The default value is 00, which forces the iServer to forward the data to the Ethernet as it receives the data on its serial port (this means that the iServer requires NO “end character” to forward the data).

Forward End Char: If enabled, the iServer will send the End Character out to the Ethernet as part of the data. If disabled, the iServer will not count the End Character as part of the data and will drop it (default is enabled.)

Timeout: In RS232 connection, if the iServer does not receive any more serial data within the given time value, the iServer will forward the buffered serial data to the Ethernet. For example, if the Timeout is set to 200 ms, the iServer will send out the buffered serial data to the LAN, if it does not receive any more data on its serial port for a period of 200 ms.

In RS485 connection, the Timeout value is used to switch between serial transmit and receive mode. Since the iServer supports 2-wire RS485, it needs to either transmit or receive serial data and the Timeout value determines the time interval for each. The range can be from 0 to 9999 ms (default is 500 ms).

4.5.4.B Terminal Server

TCP/UDP: The iServer supports TCP and UDP protocol (default is TCP). If UDP is selected, it can be configured either for Broadcast UDP or Directed UDP. In case of Broadcast UDP, the iServer will transmit the serial data to every node on the network. This can be accomplished if the Remote IP Address is set to **255.255.255.255**.

The Broadcast UDP is a practical solution when one device needs to communicate with multiple PC's or devices over the network (one-to-many connection). In the case of directed UDP, the iServer will transmit the serial data to a specific node on the network (one-to-one connection). This can be accomplished if the Remote IP Address is set to the IP address of that specific node.

Server Type: In most cases the iServer will be acting as a Slave device. Slave option is chosen when a network host needs to connect to the serial port of the iServer (default is Slave)

Number of Connections: The range is from 0 to 5. If 0 is selected, the Terminal Server feature is disabled. That means that no network connection can be made to the serial port of the iServer. If 1 is selected, only one network connection can be made to the iServer's serial port. Any number more than 1 would allow the network hosts to monitor (read only) the traffic on the iServer's serial port simultaneously, but only one network host would be allowed to read and write (default is 0).

Local Port: This is the port or socket number for the iServer's serial port. Any number between 500 and 9999 can be defined with the exceptions of 1000 and 2002 which are already used by the iServer for other purposes.

Note

If the “Number of Connections” is set to 0, the iServer’s “Local Port” will be 1000, regardless of the displayed value inside the “Local Port” box. Once the “Number of Connections” is changed to a non-zero number (1 - 5) the “Local Port” value will be what is inside the box, this value by default indicates 2000 and is changable.

4.5.4.B Terminal Server (continued)

Connection Control: Some serial devices accept connections or disconnect connections based on certain signal conditions. For example, a serial device may accept a connection only if the incoming DTR signal (connected to device's DSR or DCD) is high or low. In this case, when the iServer receives the TCP connection, before it forwards it to its serial port, it must raise its DTR (DTR+) or to lower its DTR (DTR-). The iServer is capable of doing this with any of the hardware or modem control signals (DTR, DSR, DCD, RTS, and CTS).

Note 

"Reconnect" is one of the options in the Connection Control menu. This option can be used in the Serial Tunneling described in **Section 4.11**. If the connection in Serial Tunneling is broken due to network problems, power failure, etc., the Reconnect option will try to get the connection back on line every whatever the "Connection Timeout" is set to. For Example, if the Connection Timeout is set to 1000 x10 ms or 10 seconds, then every 10 seconds the iServer attempts to reconnect and reestablish the serial tunnel to the other network node.

Device No.: Refer to **Section 4.5.1**

4.5.4C Remote Access: This option needs to be enabled when Serial Tunneling is configured. The Serial Tunneling is explained in detail in **Section 4.11**.

Note 

Changes made in the iServer's Configuration page can be saved permanently by pressing the Save button. Pressing the Reset button will set all the fields back to their default values.

4.5.5 Access Control

This section describes the "Access Control" page of the iServer's Web interface. This page allows the users to set up the network and security parameters of the iServer.

To get into the Access Control page, the user will be prompted with an Administrator Password. The default Admin password is **00000000** and is changeable, if desired.

At the initial entrance to the "Access Control" page you will be prompted for the Login Password (see **Figure 4.4**) prior to an Administrator Password.

The screenshot shows a web browser window titled "ACCESS CONTROL" with the address "http://192.168.1.200". The main content area has a large heading "ACCESS CONTROL" and a form with the following fields and values:

Login Password	12345678
Admin Password	00000000
Web Server	enable
Host Name	eis21d9
MAC Address	00:03:03:00:21:D9
IP Address	192.168.1.200
Gateway Address	0.0.0.0
Subnet Mask	255.255.255.0

Below the form are buttons for "Save", "Reset", and "Power Recycle", and a link for "Main Menu".

Figure 4.11 Access Control

Login Password: This allows users to access and modify all of the iServer Home Page menu items, except "Access Control", which requires an Administrator password. The default Login password is **12345678**. This password can be up to 16 alpha-numeric case-sensitive characters.

If there is no Login Password assigned (blank box) the iServer will not require a password to access and modify iServer Home page menu items.

Admin (administrator) Password: This allows users to access and modify the "Access Control" page. The default password is **00000000**. This password can be up to 16 alpha-numeric case-sensitive characters.

If there is no Administrator Password assigned (blank box) the iServer will not require password to access and modify "Access Control" page.

Web Server: This will allow or disallow accessing the iServer's Web server using an Internet browser (default is enabled.)

4.5.5 Access Control (continued)

Host Name: Refer to **Section 3.4**, DNS.

MAC Address: This is also called Hardware address or Ethernet address, which is assigned to the iServer at production. The MAC (Media Access Control) address is the iServer's unique hardware number and is not changeable.

IP Address: The IP (Internet Protocol) address is a 32-bit number that identifies each sender or receiver of information that is sent in packets across the Ethernet or the Internet. The iServer's default IP address is **192.168.1.200**. The iServer's IP address should be changed to fit user's networking environment. Consult with your IT department for obtaining an IP address.



The DHCP will be enabled in the iServer if its IP address is set to 0.0.0.0. The DHCP can also be enabled by setting the dip switch number 3 to ON position.

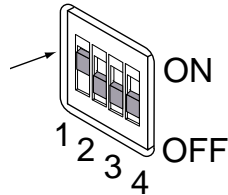

Gateway Address: A gateway is a network point that acts as an entrance to another network. A gateway is often associated with a router, which knows where to direct a given packet of data that arrives at the gateway. If the iServer is sending packets to another network node that is not on the same network on which the iServer is connected, a gateway address needs to be given to the iServer. The gateway address should be the IP address of the router connected to the same LAN to which the iServer is connected. The iServer's default gateway address is 0.0.0.0. Consult with your IT department for obtaining a gateway address.

Subnet Mask: It's a 32-bit number that is used to determine which part of the IP address



Changes made in the iServer's Access Control page can be saved permanently by pressing the Save button and power recycling the iServer (press Power Recycle button). Pressing the Reset button will set all the fields back to their default values.

4.6 Setting a New IP Address over the Network

The iServer is shipped with a default IP address of **192.168.1.200** and Subnet Mask of **255.255.255.0**. You can configure your PC's Network connection with an IP address that is in the same range as the iServer's IP address (**192.168.1.x**) and connect to the iServer using a crossover network cable between your PC and the iServer.

With this completed, you can go to the DOS-Prompt and ping **192.168.1.200**. If you receive responses back (similar to **Figure 4.1**), you can go to the Web browser and type in **<http://192.168.1.200>** and it will take you to the Device Type page and then to the Home Page.

Select Access Control button, you'll be asked for the password. First default Login password is "**12345678**" and the Admin password is "**00000000**", then you should be on the administrator setup page where you can simply type in the desired Static IP address, and click Save.

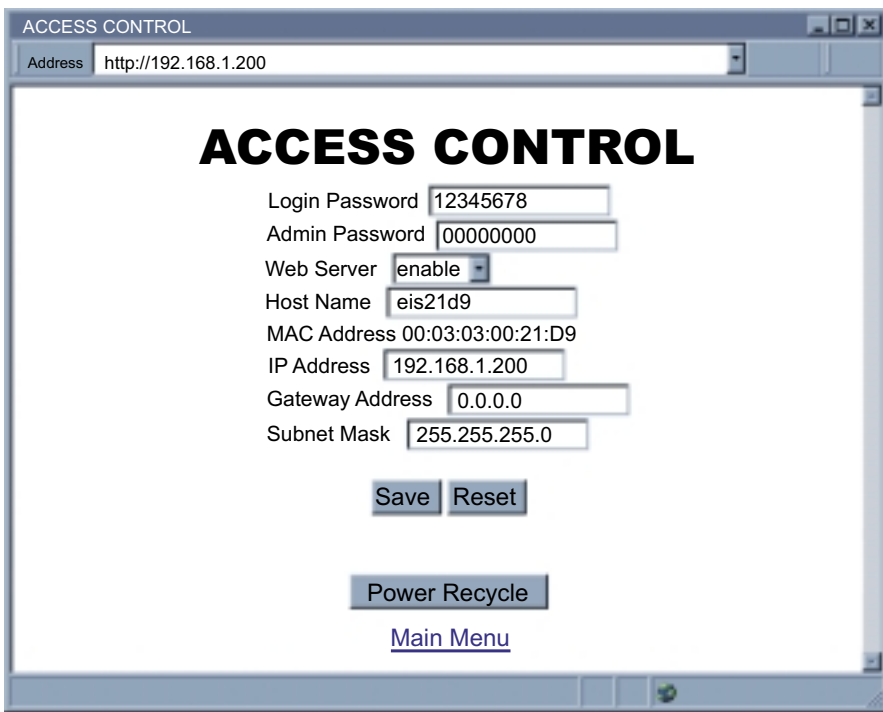

The screenshot shows a web browser window titled "ACCESS CONTROL" with the address bar set to "http://192.168.1.200". The main content area displays the "ACCESS CONTROL" title in large bold letters. Below the title are several configuration fields, each with a text input box and a label: "Login Password" (12345678), "Admin Password" (00000000), "Web Server" (enable), "Host Name" (eis21d9), "MAC Address" (00:03:03:00:21:D9), "IP Address" (192.168.1.200), "Gateway Address" (0.0.0.0), and "Subnet Mask" (255.255.255.0). At the bottom of the form are three buttons: "Save", "Reset", and "Power Recycle". A "Main Menu" link is also visible at the bottom of the page.

Figure 4.12 Access Control



For the IP address to take effect the iServer needs to be turned OFF/ON or press the Reset button.

Once all of this is done, you can connect the iServer to an Ethernet hub using a straight through cable, power it up, and follow the ping routine mentioned in the previous section.

4.7 Terminal Server Function

It is used to provide dedicated connectivity between computers and serial devices through the iServer over the Ethernet, without dedicated wiring. The typical Internet protocol consists of a request and a replay to that request. In this situation the server is the Host that generates the request and receives the replay from the device, that gets forwarded to the appropriate party on the network. But there are specific applications where a message is generated by the device, and the server is simply passing the data to the appropriate party on the network, in this situation the server acts as Slave. Examples are the Attendance Time Clocks, Bar Code Readers, remote Displays or Electronic signboards, etc.

For the iServer to pass the data back and forth between its Serial and Ethernet interfaces, the Terminal Server option needs to be configured as follows (**Figure 4.13**):

1. Set the Server Type to **Slave**
2. Set the Number of Connections to **0**.
3. Set the **Local Port** or Socket number to any number from 599 - 65535, except numbers 1000 and 2002.
4. Press the **Save** button to store the new settings.

From your application software on the host machine, you can now point to the IP address of the iServer and the assigned port number to establish a TCP connection to your serial device connected to the serial port of the iServer.

Note If DIP switch #4 is "ON",

Terminal Server function is always enabled, regardless of the firmware configuration.

By default, this DIP switch is set to "OFF" position.

You have the option to enable the Terminal Server feature either through the firmware or the DIP switch #4.

The screenshot shows a web browser window titled "CONFIGURATION" with the address "http://192.168.1.200". The main heading is "CONFIGURATION" followed by "Serial Communication". The settings are as follows:

- Baud Rate: 9600
- Data Bit: 7 Bits
- Parity: odd
- Stop Bits: 1 bit
- Flow Control: none
- Transceiver: RS-485
- Modbus/TCP: disable
- End Character (Hex): 0D
- Forward End Char: enable
- Timeout: 0500 msec
- Serial Port Password: disable, 1234abcd

The next section is "Terminal Server":

- TCP/UDP: TCP
- Server Type: slave
- Number of Connections: 0
- Local Port: 02000
- Connection Ctrl: not used
- Device No.: 1
- Connection Timeout: 00100 msec

The final section is "Remote Access (Tunneling)":

- Remote Access: disable
- Remote IP Address: 0.0.0.0
- Remote Port: 02000

At the bottom, there are "Save" and "Reset" buttons, and a "Main Menu" link.

Figure 4.13 Terminal Server Configuration

4.8 Terminal Emulation

On this page you can send and receive data to and from the instrument. Simply, type the command in the open window and as you type the characters, the characters will be transmitted out from the serial port of the iServer.

If the command is more than one character, you must type the command in a different window and then use “copy” and “paste” options to drop the command in the Terminal Emulation window (the right mouse button will give you “copy” and “paste” options).

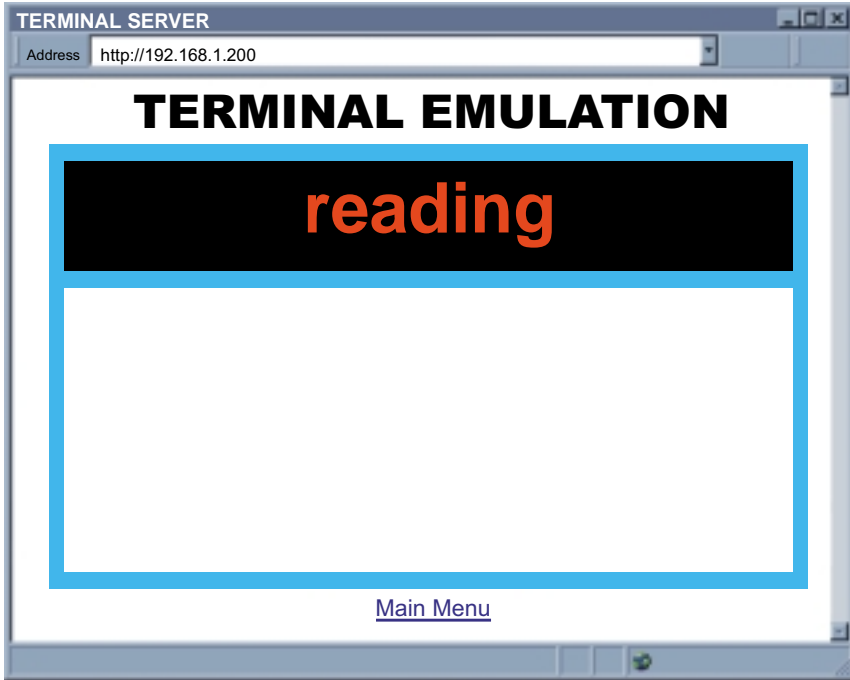

Figure 4.14 Terminal Emulation

4.9 Telnet Setup

Telnet stands for Telecommunications Network, is a protocol that provides a way for users (or clients) to connect to computers (or servers) on a network, whether in the next building or across the other side of the world.

You can open a Telnet session using other terminal emulation programs like Tera Term Pro (downloadable from the internet), which is a free software for MS-Windows. It supports VT100 emulation, Telnet connection and serial port connection.

Once the Telnet mechanism is decided we can open a session by simply typing the IP address of the iServer, and setting the Port on 2002 for logging into the iServer Configuration page or 2000 for accessing the serial device connected to the iServer's serial port.

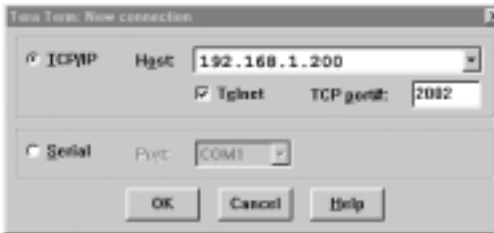

Figure 4.15
Tera Term Telnet Connection Screen

```
Firmware Version 4.1
Admin Password:00000000
Admin. Login Successful
P Configuration
Firmware Version 4.1
BD = 9600 (5)
PT = odd (1)
ST = 1 bit (0)
DT = 7 bits (0)
MD = RS-485 (1)
TO = 500
TT = SLAVE (1)
TN = 0
HN = eis1376
IP = 192.168.1.200
LP = 12345678
SP = 00000000
TP = iSeries (3)
RE = enable (1)
RI = 0.0.0.0
RP = 02000
GW = 0.0.0.0
SM = 255.255.255.0
EC = 0D
PP = 02000
FC = None (0)
MB = disable(0)
TU = TCP (0)
CC = not used(0)
CT = 01000
FE = enable (1)
EP = disable(0)
CP = 1234abcd
WB = enable (1)
MAC = 00:03:34:00:13:76
q
Quit
```

Figure 4.16 Telnet Setup
iServer Configuration Page



The default password for Telnet Login is 00000000 and can be changed if desired. Telnet works only in RS-232 mode

4.9 Telnet Setup (continued)

In the Configuration mode you can make any changes just like you would do using the Web Browser. After connected to the iServer, the user can use the following commands to read, modify, and get help from the iServer console.

? Following with a return character, the console will show all the commands and options (**Figure 4.17**).

p Following with a return character, the console will show the iServer configurations (**Figure 4.16**).

s Is the configuration command, used to set a new setting (see the example in **Figure 4.17**)

r This command is used to read the status of the digital I/O signals (0 is low and 1 is high)

```
Example:      r DCD      response will be   DCD (DSR)=0
              r DTR      response will be   DTR=0
```

w This command is used to change the status of the digital I/O signals (applies only to the outgoing signals, DTR and RTS)

```
Example :     w RTS=1  means raise the RTS
              w DTR=0  means lower the DTR
```

RESET following with a return character, it will recycle the Power on the iServer.

FACTORY following with a return character, it will set the iServer to it's factory default settings.

```
Admin. Password:00000000
Admin. Login Successful
iServer Configuration Command:
?
cc description          pppppp
BD BaudRate            0-300,1-600,2-1200,3-2400,4-4800,5-9600,6-19200,
                      7-38400, 8-57600, 9-115200
PT Parity              0-none,1-Odd,2-even
ST StopBits            0-1bits,1-2bits
DT DataBits            0-7bits,1-8bits
FC FlowControl         0-none,1-XON/XOFF,2-Hardware
MD Mode                0-RS232, 1-RS485
MB Modbus/TCP          0-disable, 1-enable
TO Timeout             xxxx ms Rang range 100-9999
TU TCP/UDP             0-TCP, 1-UDP
TT TerminalType        0-Host, 1-Slave
TN TerminalNumber      0-5
PP TerminalPort        XXXXX 500-65535 but 1000 and 2002
HN HostName            XXXXXXXX maxim 18 characters
IP Static IP           XXX.XXX.XXX.XXX
LP Login Password      XXXXXX maxim 16 characters
SP Admin Password      XXXXXX maxim 16 characters
TP Device Type         0-iServer,1-iDRN,2-iDRX,3-iSeries,4-iNFB,5-iLD
RE Remote Enable       0-Disable, 1-Enable
RI Remote IP           XXX.XXX.XXX.XXX
RP Remote Port         XXXXX 500-65535 but 1000 and 2002
GW Gateway             XXX.XXX.XXX.XXX
EC End Char            XX represents the Hex Num. of ASCII. i.e 0D means CR
                      (Carrige Return)
FE Forward End Char    0-disabled, 1-enabled
EP Enable Serial Port Password 0-disabled, 1-enabled
CP Serial Port Password XXXXXX maxim 16 characters
CC Connect CTRL        0-not used,1-RTS+,2-RTS-,3-CTS+,4-CTS-,5-RTS-CTS+,
                      6-RTS-CTS-, 7-DTS+,8-DTR-, 9-DCD/DSR+,
                      A-DCD/DSR-, B-DTR-DCD+, C-DTR-DCD-, D-RECONNECT
CT Connect Timeout     XXXXX 1-65535
WB Web Server          0-disable, 1-enable
Example:
To configure Baudrate 9600, 1 stop bit, Odd Parity, and RS232 mode.
s -BD5 -PT1 -ST1 -MD0
```

Figure 4.17 Telnet Setup - iServer Help Page

4.10 HTTPGET Program

You can setup and read the information from the iServer by using the HTTPGET program. The following program can be used to read data from the embedded server firmware by using TCP port **1000**. The command string sends to this TCP port, then it reads back the response from the same port. Whatever you write to the port goes to the serial port unmodified. Any response from the serial port can be read back from the same socket.

The Httpget.exe file is used to setup and read information from the iServer. This file will be automatically installed when you run any iServer related software available on our website and CD.

Example to use the "**Httpget**" program:

1. Create a directory **C:\iServer\Httpget**.
2. Copy httpget.exe and readme_features.doc files to this directory.
3. Make sure that you are in this directory and then enter the following test program:

```
C:\iServer\Httpget\httpget -r -S ""01X01\r" 192.168.1.200:1000
```

where:

"-r -S" are switches before the command string

"01" is device address (in hex format) for RS485 communication interface (skip for RS232)

"X01" read measurement data value (iSeries protocol)

"\r" calls out a CR

"192.168.1.200" is an IP address

"1000" is a local port number

Respond:

```
01X01074.3
```

where:

"01X01" is Echo command

"074.3" is a display reading of the 4-digit device



In the example above the 4-digit iSeries controller has been connected to the serial communication port of iServer.

4.11 ARP Protocol

ARP is the Internet layer protocol responsible for determining the MAC (hardware) address that corresponds to a particular IP address. The ARP command allows the user to view the current contents of the ARP cache of the local computer (residing on the same network) or remote computer (residing on the different network) through a router.

Microsoft includes the ARP.EXE utility for viewing and modifying the ARP cache with its Windows products. The following ARP commands can be used to view cache entries:

- **arp -a** → Use this command to view all ARP cache entries.
- **arp -a** plus **IP address** → Use this command to view ARP cache entries associated with one particular interface on a network with multiple adapters.
- **arp -g** → Same as arp -a.
- **arp -N** → Use this command to display ARP entries for specific network interface.
- **arp -s** plus **IP address** plus **Physical address** → Use this command to manually add a permanent static entry to the ARP cache.
- **arp -d** → Use this command to manually delete a static entry.

Note Ping the destination computer using IP address first before using the arp -a command.

The following window shows examples of arp commands and responses.

- Your computer has an IP address of **192.168.1.118**
- The destination computer has an IP address of **192.168.1.96**

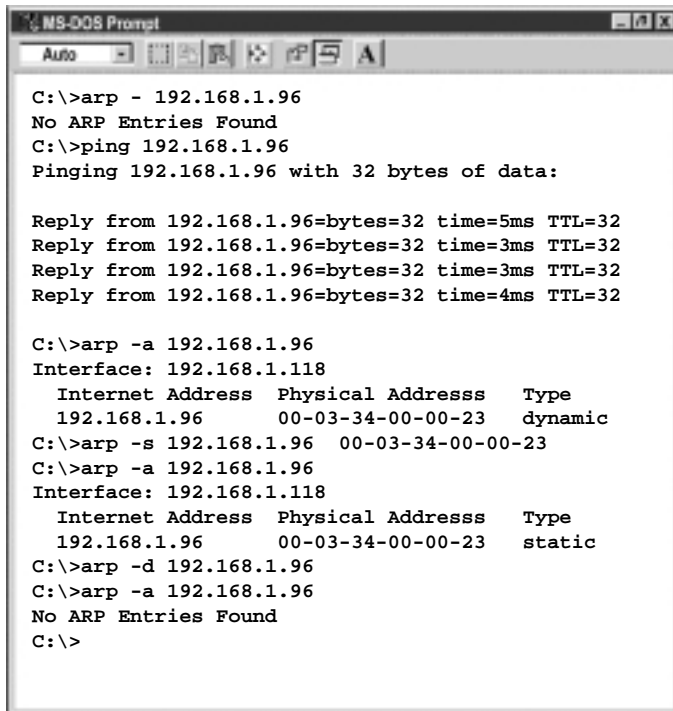

```
C:\>arp - 192.168.1.96
No ARP Entries Found
C:\>ping 192.168.1.96
Pinging 192.168.1.96 with 32 bytes of data:

Reply from 192.168.1.96=bytes=32 time=5ms TTL=32
Reply from 192.168.1.96=bytes=32 time=3ms TTL=32
Reply from 192.168.1.96=bytes=32 time=3ms TTL=32
Reply from 192.168.1.96=bytes=32 time=4ms TTL=32

C:\>arp -a 192.168.1.96
Interface: 192.168.1.118
    Internet Address  Physical Addresss  Type
    192.168.1.96      00-03-34-00-00-23  dynamic
C:\>arp -s 192.168.1.96 00-03-34-00-00-23
C:\>arp -a 192.168.1.96
Interface: 192.168.1.118
    Internet Address  Physical Addresss  Type
    192.168.1.96      00-03-34-00-00-23  static
C:\>arp -d 192.168.1.96
C:\>arp -a 192.168.1.96
No ARP Entries Found
C:\>
```

Figure 4.18 ARP Commands and Responses

4.12 Remote Access (Tunneling)

To "tunnel", in this context, is to transmit data between two points through a private conduit on a shared or public network. The network could be an Ethernet LAN, a WAN, or the Internet. The iServer allows for a connection between a serial device and a PC, or between two serial devices, using an existing network rather than dedicated wiring.

Today, there are number of serial devices like sensors, gauges, PLCs, card readers, security alarms, barcode scanners, data loggers, video cameras, ATM machines, time & attendance terminals, medical lab equipments, electronic signboards, and many others that are directly connected to PCs via their serial ports. These devices can be attached to shared Ethernet networks (TCP/IP protocol) and get accessed, controlled, and managed remotely using the iServer products. Any two iServer's can talk to each other over the Ethernet LAN, WAN, and Internet using TCP/IP protocol. Therefore, the connected serial devices to iServer's can also communicate with each other back and forth over these networks. This characteristic is called Tunneling and it's illustrated below.

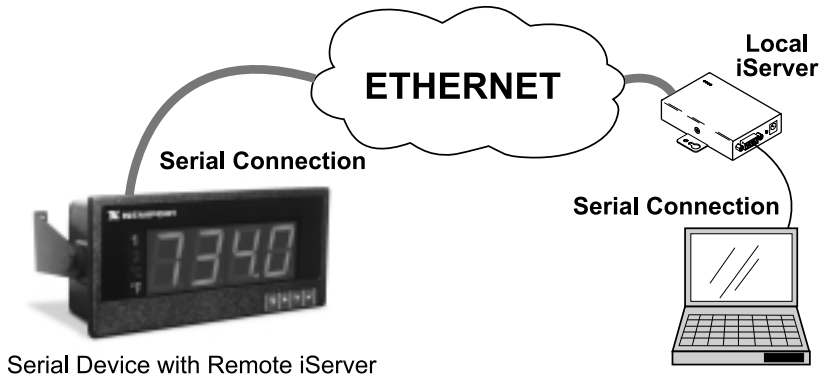

Figure 4.19 PC-to-Device Communication

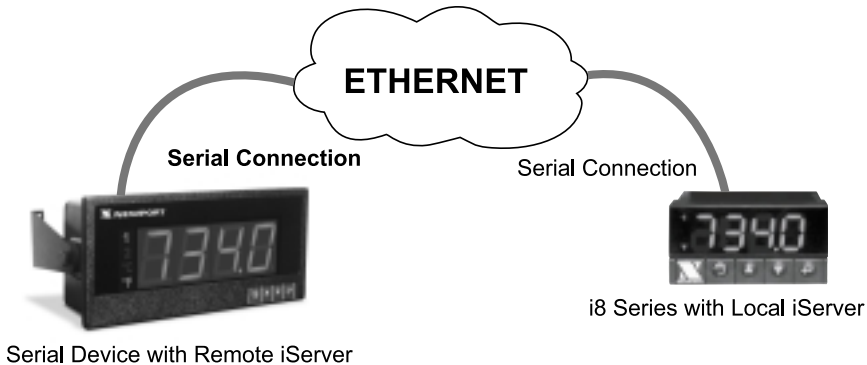

Figure 4.20 Device-to-Device Communication

In order to use this Tunneling feature, some settings are required within the local and remote iServer's.

4.12.1 Remote iServer

It's recommended to configure the Remote iServer and have it up and running before the Local iServer is configured.

1. A static IP address must be assigned to the Remote iServer. This means that the DHCP must remain disabled. Refer to the DHCP section of the user's manual for details.
2. Use a browser to access the Remote iServer's WEB page. Simply type the iServer's IP address at the browser's URL location (i.e. **192.168.1.50**) followed by an **Enter** key. You should then see the iServer's main WEB page.
3. Click on the **Update** button.
4. Click on **Configuration**, you will be prompted with a **Password** (default is **12345678**).
5. On the **Configuration** page, under **Serial Communication** section, make sure the parameters such as Baud Rate, Data Bits, Parity, Stop Bits, Flow Control, etc. match with your attached serial device.
6. Make sure to set the **End Character (Hex)** to **0D** and the **Timeout** to **500**.
7. Under **Terminal Server** section, set **Number of Connections** to **1** or higher.
8. Click on **Save** button for the changes to take place.

Make sure that the serial cable and communication settings between the iServer and the serial device are valid.

Note **Figure 4.21** shows the valid values that need to be set in the Remote iServer. The Baud Rate, Data Bits, Parity, Stop Bits, Flow Control, and Transceiver values depend on what the serial device supports.

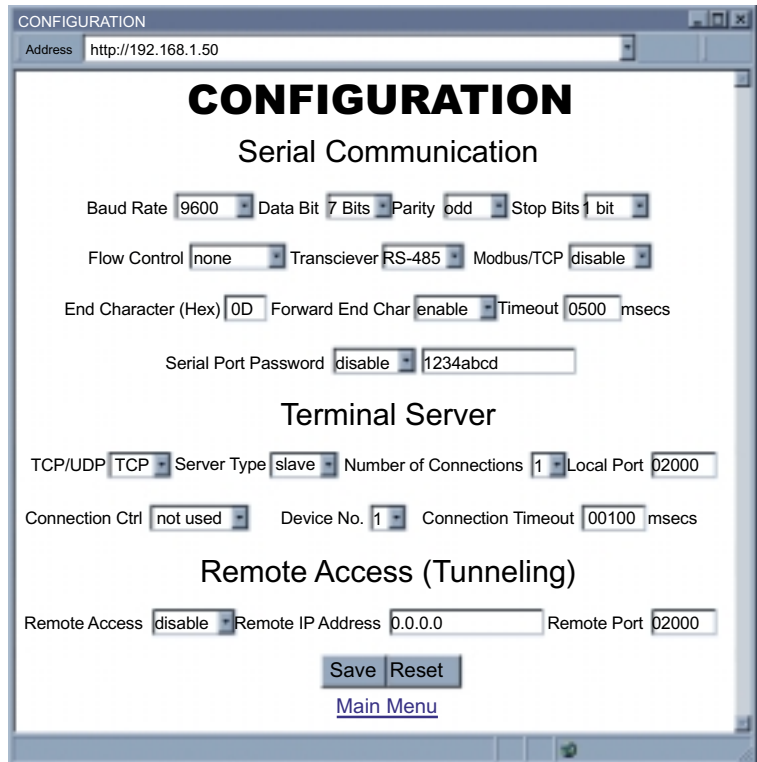

Figure 4.21 Configuration Menu - Remote iServer

4.12.2 Local iServer

1. An IP address should be assigned to the iServer dynamically or statically (recommended).
2. Use a browser to access the Local iServer's WEB page. Simply type the iServer's IP address at the browser's URL location (i.e. **192.168.1.49**) followed by an **Enter** key. You should then see the iServer's main WEB page.
3. Click on the **Update** button.
4. Click on **Configuration**, you will be prompted with a **Password** (default is **12345678**).
5. On the **Configuration** page, under **Serial Communication** section, make sure the parameters such as Baud Rate, Data Bits, Parity, Stop Bits, Flow Control, etc. match with your attached serial device and its application software.
6. Make sure to set the **End Character (Hex)** to **0D** and the **Timeout** to **500**.
7. Under **Terminal Server** section, set **Number of Connections** to **0**.
8. Under **Remote Access** section, set the **Remote Access** to **enable**, Enter the **Remote IP address** (would be the IP address of the remote iServer, **192.168.1.50**), and use the default **Remote Port** number **2000**.
9. Set **Connection Control** to **Reconnect** and set the **Connection Timeout** to a desired value.

Note

The **Reconnect** option is used in Serial Tunneling and it applies only to the Local iServer. If the tunneling connection between the two iServers goes down due to network problems, power failure, etc., the Reconnect option will enable the Local iServer to reconnect with the Remote iServer based on the specified time interval in the **Connection Timeout**. For example, based on a timeout of 1000 x 10 ms (10 seconds), the Local iServer will continually attempt to reconnect and re-establish the tunnel with the Remote iServer every 10 seconds.

10. Click on **Save** button for the changes to take place.
11. Initialize the serial device application software to establish the connection.

Note

Figure 4.22 shows the valid values that need to be set in the Local

iServer. The Baud Rate, Data Bits, Parity, Stop Bits, Flow Control, and Transceiver values depend on what the attached device to the iServer supports.

CONFIGURATION
Address http://192.168.1.49

CONFIGURATION

Serial Communication

Baud Rate 9600 Data Bit 7 Bits Parity odd Stop Bits 1 bit
Flow Control none Transceiver RS-485 Modbus/TCP disable
End Character (Hex) 0D Forward End Char enable Timeout 0500 msec
Serial Port Password disable 1234abcd

Terminal Server

TCP/UDP TCP Server Type slave Number of Connections 0 Local Port 02000
Connection Ctrl reconnect Device No. 1 Connection Timeout 00100 msec

Remote Access (Tunneling)

Remote Access enable Remote IP Address 192.168.1.50 Remote Port 02000

Save Reset
[Main Menu](#)

Figure 4.22 Configuration Menu - Local iServer

4.13 Mail Notifier Software

The Mail Notifier Software can be used only with NEWPORT Electronics instruments. For complete information of how to use the Mail Notifier software, click on the Help menu of the main window.

The Mail Notifier software generates email notifications for alarm conditions. Users can be notified automatically of alarm conditions monitored via internet connections throughout the world. By use of the email forwarding of alarm conditions, alarm conditions can be monitored on a network isolated from the internet and forwarded to connections on the Internet.

The Mail Notifier utility operates under Windows 98, NT 4.0, 2000, and XP in conjunction with existing email that supports the MAPI messaging interface. If MS Outlook has been loaded, the MAPI support should be available.

4.13.1 Installation

The Mail Notifier must be loaded on a computer running Microsoft Windows (versions specified earlier) using an email program that provides MAPI access. Network access must be available between this computer and the iServer. Network access must also be available from this computer to the appropriate email server and from the email server to the recipient's email server.

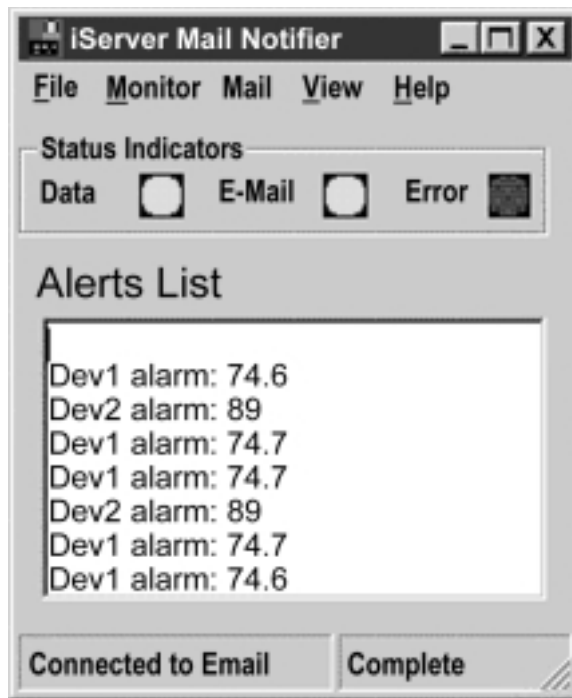

Figure 4.23 iServer Mail Notifier Main Window

4.13.2 Program Options Setup and Configuration

Complete program setup requires:

- Entering a recipient for the email
- Specifying connection details to MAPI services.
- Defining alarms for devices, and selecting how and when the email will be active.

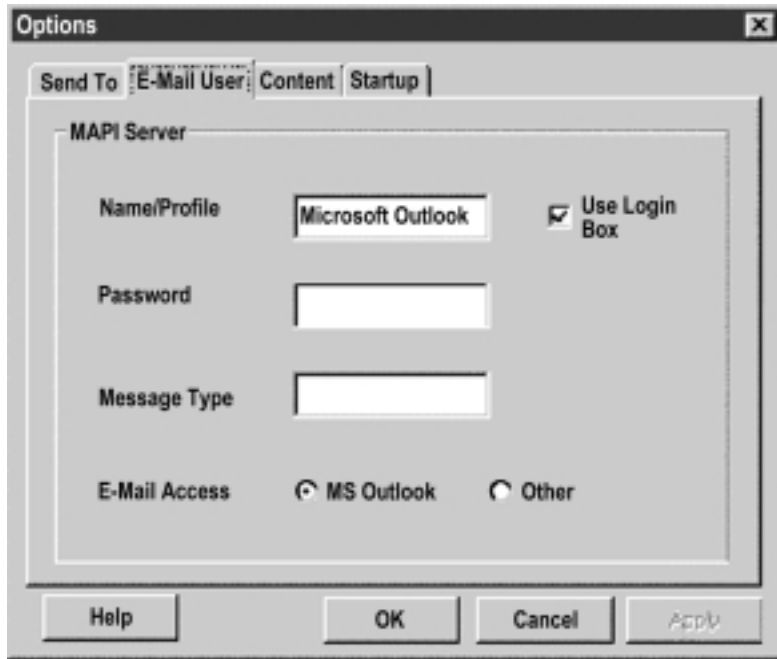

Figure 4.24 iServer Mail Notifier Profile Setup

The "Send To" tab contains a field to specify an email address to which alarm notifications will be sent (i.e. the recipient). Only one entry is permitted, in the address field. Additional addresses can be placed into "More Addresses" list.

Email Connection (MAPI Access)

The following instructions work with some versions of Microsoft Outlook. Note though that some email systems may prevent the use of Mail Notifier due to security constraints.

The simplest way to obtain a connection the the Email services is as follows:

1. Configure the Mail Notifier to connect to the email by displaying a Login Box. This option is found by selecting View, Options from the Mail Notifier's menubar. Select the "Email Setup" tab, mark the checkbox for "Use Login Box"
2. After Mail Notifier is configured to use the login box, the Mail Notifier can be started without user intervention if your MS Outlook program is running beforehand. Otherwise, the Mail Notifier will display a Login Box that should display the necessary User Profile.

4.12.3 Device Setting and Configuration

Device setup requires:

- Entering the IP address for iServer device (for example **192.168.1.200**).
- Specifying Socket number (1000 or 2000 depending on iServer settings).
- Defining RS485 Unit # interface address (1 to 199). Enter "0" for RS232 interface or for iServer.
- Entering Reading command. Normally set to **X01** to obtain reading from the devices. If you want to change this setting, refer to HTTPget **Section 4.10**.
- Defining the Alarm setup (High/Low, High value, or Low value).
- Specifying Pause Interval. It determines how many seconds each subsequent alarm notification will be sent.
- Determining Monitor interval. It establishes the interval or time resolution in seconds for which readings will be obtained from the device.

The screenshot shows a dialog box titled "Alarm Editor" with a close button (X) in the top right corner. The dialog is divided into two main sections: "device info (2 of 2)" and "Alarm Configuration".

device info (2 of 2)

Server IP Address	192.168.1.200
Socket Number	1000
RS485 Unit #	1
Description	iServer
Src ID	Dev 2
Reading Cmd	SRTF

Navigation buttons: Up, Down, Add, Del, OK, Cancel, Help.

Alarm Configuration

Alarm Type	Alarm Low	Info Message	Alarm triggered
Alarm High	70	Pause Interval	60
Alarm Low	100	Monitor Interval	5

Figure 4.25 iServer Mail Notifier Device Setting

PART 5 SPECIFICATIONS

SERIAL INTERFACE

Interface:

RS-422 or RS-485 (2 wire)

Data Rates:

300 to 115200 bps

Characters:

7 or 8 data bits

Parity:

odd, even, or none

Stop bits:

1 or 2

Flow Control:

Software (Xon/Xoff)

Hardware (CTS/RTS)

NETWORK INTERFACE

Interface:

Ethernet 10 Base-T

Connector:

RJ45

Protocols:

ARP, TCP/IP, ICMP, DNS, DHCP,
Telnet simulation and HTTP

Indicators (LED):

Col / Network Activity (red),
On / Network Link (green),
TX-Transmit (yellow),
RX-Receive (green),
Power (green)

PROCESSOR

CPU:

Enhanced 8051, 22 MHz

Memory:

16 Kbyte SRAM, 512 Kbyte Flash

Management:

Serial Login, Telnet Login,
Internal Web Server

INTERNAL WEB SERVER

Uses: Dynamic web pages and Java applets (256 Kbyte capacity)

ENVIRONMENTAL

Operating Temperature:

0 to 50°C (32 to 122°F) 90%RH

Power Input

10-32 Vdc

Consumption:

2 W max

GENERAL

Agency Approvals

FCC-B, C/UL, CE

Software

Firmware upgradeable. Compatible with Windows 9x / ME / NT / 2000 / XP software and related utilities

Note

Refer to the iSeries Manual and Quickstart for physical characteristics of iSeries devices with the Embedded Ethernet Server.

**PART 6
FACTORY PRESET VALUES**

PRESET PARAMETERS	FACTORY DEFAULTS
Network Interface:	
IP Address	192.168.1.200
Gateway Address	0.0.0.0
Subnet Mask	255.255.255.0
Device Host Name	eis and Last 4 digits from the MAC address
Login Password	12345678
Admin Password	00000000
DHCP	Disabled
Serial Interface:	
Communication Protocol	RS-485
Flow Control	None
Baud Rate	9600
Parity	Odd
Stop Bit	1 bit
Data Bit	7 bits
Timeout	500 msec
End Character	0D (Hex) (Carridge Return)
Terminal Server:	
Server Type	Slave
Number of Connections	0
Port #	1000
Server Mode	Disable
Remote Access (Tunneling):	
Remote Access	Disable
Remote Port	2000
Remote IP Address	0.0.0.0

User of this manual should be familiar with following definitions:

ARP (Address Resolution Protocol) is a protocol for mapping an Internet Protocol address (IP address) to a physical machine address that is recognized in the local network. For example, the IP address in use today is an address that is 32-bits long. In an Ethernet local area network, however, addresses for attached devices are 48-bits long. (The physical machine address is also known as a Media Access Control or MAC address.) A table, usually called the ARP cache, is used to maintain a correlation between each MAC address and its corresponding IP address. ARP provides the protocol rules for making this correlation and providing address conversion in both directions.

Ethernet is a network protocol defined by the IEEE 802.3 standard. Ethernet-based networks use MAC Address rather than IP Address to exchange data between computers. By using ARP and adding TCP/IP support, Ethernet devices may be connected as part of the Internet. An Ethernet LAN typically uses coaxial cable or special grades of twisted pair wires. The most commonly installed Ethernet systems are called 10BASE-T and provide transmission speeds up to 10 Mbps. Devices are connected to the cable and compete for access using a Carrier Sense Multiple Access with Collision Detection (CSMA/CD) protocol.

IP (Internet Protocol) is the method or protocol by which data is sent from one computer to another on the Internet.

IP address (Internet Protocol address) is a 32-bit number that identifies each sender or receiver of information that is sent in packets across the Internet.

IP Netmask is a 32-bit pattern of bits used to determine which part of the IP address is the network portion and which part is the host portion.

MAC (Media Access Control) Address is your computer's unique hardware number. When you're connected to the Internet from your computer, a correspondence table relates your IP address to your computer's physical (MAC) address on the LAN.

Ping is a utility that tests the network connectivity. It is used to determine if the host is capable of exchanging information with another host.

Port number/Socket number is a way to identify a specific process to which an Internet or other network message is to be forwarded when it arrives at a server. It is a predefined address that serves as a route from the application to the Transport layer or from the Transport layer to the application of the TCP/IP system.

Sockets are a method for communication between a client program and a server program in a network and defined as "the endpoint in a connection." Information transferred across the Internet primarily occurs between sockets.

TCP/IP (Transmission Control Protocol/Internet Protocol) is the basic communication language or protocol of the Internet. When you are set up with direct access to the Internet, your computer is provided with a copy of the TCP/IP program just as every other computer that you may send messages to or get information from also has a copy of TCP/IP. TCP/IP often is used as a general term to indicate generic access to the Internet.

Appendix B

IP Address

An IP address is a unique 32-bit address assigned to a computer and includes:

- A network ID number identifying a network.
- A host ID number identifying a computer on the network.

All IP addresses have been divided into three smaller groups (classes) A, B and C

- **Class A** addresses have 8-bits of network ID and 24-bits of host ID. They can support a large number of hosts, approximately $2^{24} = 16,777,216$ computers per network.

The IP addresses range in binary from 00000001.xxxxxxxx.xxxxxxxx.xxxxxxxx
to 01111111.xxxxxxxx.xxxxxxxx.xxxxxxxx

The IP addresses range in decimal from 1.x.x.x to 127.x.x.x

Class A network ID's support a very large number of hosts.

- **Class B** addresses have 16-bits of network ID and 16-bits of host ID. They can support approximately $2^{16} = 65,536$ computers per network.

The IP addresses range in binary from 10000000 00000000.xxxxxxxx.xxxxxxxx
to 10111111 11111111.xxxxxxxx.xxxxxxxx

The IP addresses range in decimal from 128.0.x.x to 191.255.xxx.xxx

Class B network ID's support a medium number of hosts.

- **Class C** addresses have 24-bits of network ID and 8-bits of host ID. They can support approximately $2^8 = 256$ computers per network.

The IP addresses range in binary from 11000000.00000000.00000000.xxxxxxxx
to 11011111.11111111.11111111.xxxxxxxx

The IP addresses range in decimal from 192.0.0.xxx to 223.255.255.xxx

Class C network ID's support a small number of hosts.



The rest of the addresses are divided into two classes, D and E.

Class D networks are not assigned to the host. They are used for multicasting. The address range from 224.x.x.x to 239.x.x.x

Class E networks are experimental or reserved addresses. The address range from 240.x.x.x to 247.x.x.x

Appendix C

IP Netmask

IP Netmask or Subnet Mask is a 32-bit pattern of ones and zeros used to determine network portion of an IP address from the host portion of the IP address. Subnet mask is a network ID that is created by borrowing bits from host portion of IP address and using them as part of a network ID. The table below shows a default subnet mask for address Classes A, B, and C. Each bit that is set to "1" in the subnet mask corresponds to the bit in the IP address that is to be used as the network ID. Each bit that is set to "0" in the subnet mask corresponds to a bit in the IP address that is to be used as the host ID.

Address Class	Mask Binary Value	Mask Decimal Value or Dotted Notation
Class A	11111111 00000000 00000000 00000000	255.0.0.0
Class B	11111111 11111111 00000000 00000000	255.255.0.0
Class C	11111111 11111111 11111111 00000000	255.255.255.0

If your network requires more network ID's, you can extend the default subnet mask to include additional bits from the host ID. This allows for additional network ID's within the network. The table below shows some examples of subnet masks and bits moved from the hosts ID to create a new subnet.

Mask Dotted Notation	Mask Binary	Mask Bits
Class A		
255.0.0.0 (Default)	11111111 00000000 00000000 00000000	0
255.192.0.0	11111111 11000000 00000000 00000000	2
255.224.0.0	11111111 11100000 00000000 00000000	3
255.240.0.0	11111111 11110000 00000000 00000000	4
255.248.0.0	11111111 11111000 00000000 00000000	5
255.252.0.0	11111111 11111100 00000000 00000000	6
255.254.0.0	11111111 11111110 00000000 00000000	7
255.255.0.0	11111111 11111111 00000000 00000000	8
255.255.128.0	11111111 11111111 10000000 00000000	9
255.255.192.0.0	11111111 11111111 11000000 00000000	10
.....
255.255.255.252	11111111 11111111 11111111 11111100	22
Class B		
255.255.0.0 (Default)	11111111 11111111 00000000 00000000	0
255.255.192.0	11111111 11111111 11000000 00000000	2
.....
255.255.255.252	11111111 11111111 11111111 11111100	14
Class C		
255.255.255.0 (Default)	11111111 11111111 11111111 00000000	0
255.255.255.192	11111111 11111111 11111111 11000000	2
.....
255.255.255.254	11111111 11111111 11111111 11111100	6

To determine the number of valid hosts ID's remaining after subnetting, use the following equation: $2^n - 2$, where n is the number of octet digits left after the subnet mask.

Appendix D

ASCII Chart

ASCII Char	Dec	Hex	Binary No Parity	ASCII Char	Dec	Hex	Binary No parity
NUL	00	00	00000000	@	64	40	01000000
SOH	01	01	00000001	A	65	41	01000000
STX	02	02	00000010	B	66	42	01000010
ETX	03	03	00000011	C	67	43	01000011
EOT	04	04	00000100	D	68	44	01000100
ENQ	05	05	00000101	E	69	45	01000101
ACK	06	06	00000110	F	70	46	01000110
BEL	07	07	00000111	G	71	47	01000111
BS	08	08	00001000	H	72	48	01001000
HT	09	09	00001001	I	73	49	01001001
LF	10	0A	00001010	J	74	4A	01001010
VT	11	0B	00001011	K	75	4B	01001011
FF	12	0C	00001100	L	76	4C	01001100
CR	13	0D	00001101	M	77	4D	01001101
SO	14	0E	00001110	N	78	4E	01001110
SI	15	0F	00001111	O	79	4F	01001111
DLE	16	10	00010000	P	80	50	01010000
DC1	17	11	00010001	Q	81	51	01010001
DC2	18	12	00010010	R	82	52	01010010
DC3	19	13	00010011	S	83	53	01010011
DC4	20	14	00010100	T	84	54	01010100
NAK	21	15	00010101	U	85	55	01010101
SYN	22	16	00010110	V	86	56	01010110
ETB	23	17	00010111	W	87	57	01010111
CAN	24	18	00011000	X	88	58	01011000
EM	25	19	00011001	Y	89	59	01011001
SUB	26	1A	00011010	Z	90	5A	01011010
ESC	27	1B	00011011	[91	5B	01011011
FS	28	1C	00011100	\	92	5C	01011100
GS	29	1D	00011101]	93	5D	01011101
RS	30	1E	00011110	^	94	5E	01011110
US	31	1F	00011111	_	95	5F	01011111
SP	32	20	00100000	`	96	60	01100000
!	33	21	00100001	a	97	61	01100001
"	34	22	00100010	b	98	62	01100010
#	35	23	00100011	c	99	63	01100011
\$	36	24	00100100	d	100	64	01100100
%	37	25	00100101	e	101	65	01100101
&	38	26	00100110	f	102	66	01100110
'	39	27	00100111	g	103	67	01100111
(40	28	00101000	h	104	68	01101000
)	41	29	00101001	i	105	69	01101001
*	42	2A	00101010	j	106	6A	01101010
+	43	2B	00101011	k	107	6B	01101011
,	44	2C	00101100	l	108	6C	01101100
-	45	2D	00101101	m	109	6D	01101101
.	46	2E	00101110	n	110	6E	01101110

Appendix D

ASCII Chart Continuation

/	47	2F	00101111	o	111	6F	01101111
0	48	30	00110000	p	112	70	01110000
1	49	31	00110001	q	113	71	01110001
2	50	32	00110010	r	114	72	01110010
3	51	33	00110011	s	115	73	01110011
4	52	34	00110100	t	116	74	01110100
5	53	35	00110101	u	117	75	01110101
6	54	36	00110110	v	118	76	01110110
7	55	37	00110111	w	119	77	01110111
8	56	38	00111000	x	120	78	01111000
9	57	39	00111001	y	121	79	01111001
:	58	3A	00111010	z	122	7A	01111010
;	59	3B	00111011	{	123	7B	01111011
<	60	3C	00111100		124	7C	01111100
=	61	3D	00111101	}	125	7D	01111101
>	62	3E	00111110	~	126	7E	01111110
?	63	3F	00111111	DEL	127	7F	01111111

ASCII Control Codes

ASCII Char	Dec	Hex	Ctrl Key Equiv.	Definition	ASCII Char	Dec	Hex	Ctrl Key Equiv.	Definition
NUL	00	00	Ctrl @	Null Character	DC1	17	11	Ctrl Q	Data Control 1 - XON
SOH	01	01	Ctrl A	Start of Header	DC2	18	12	Ctrl R	Data Control 2
STX	02	02	Ctrl B	Start of Text	DC3	19	13	Ctrl S	Data Control 3 - XOFF
ETX	03	03	Ctrl C	End of Text	DC4	20	14	Ctrl T	Data Control 4
EOT	04	04	Ctrl D	End of Transmission	NAK	21	15	Ctrl U	Negative Acknowledge
ENQ	05	05	Ctrl E	Inquiry	SYN	22	16	Ctrl V	Synchronous Idle
ACK	06	06	Ctrl F	Acknowledge	ETB	23	17	Ctrl W	End of Trans Block
BEL	07	07	Ctrl G	Bell	CAN	24	18	Ctrl X	Cancel
BS	08	08	Ctrl H	Back Space	EM	25	19	Ctrl Y	End of Medium
HT	09	09	Ctrl I	Horizontal Tabulation	SUB	26	1A	Ctrl Z	Substitute
LF	10	0A	Ctrl J	Line Feed	ESC	27	1B	Ctrl [Escape
VT	11	0B	Ctrl K	Vertical Tabulation	FS	28	1C	Ctrl \	File Separator
FF	12	0C	Ctrl L	Form Feed	GS	29	1D	Ctrl]	Group Separator
CR	13	0D	Ctrl M	Carriage Return	RS	30	1E	Ctrl	Record Separator
SO	14	0E	Ctrl N	Shift Out	US	31	1F	Ctrl _	Unit Separator
SI	15	0F	Ctrl O	Shift In	SP	32	20		Space
DLE	16	10	Ctrl P	Data Link Escape					

PART 7

APPROVALS INFORMATION

7.1 CE APPROVALS INFORMATION

 This product conforms to the EMC directive 89/336/EEC amended by 93/68/EEC, and with the European Low Voltage Directive 72/23/EEC.

Electrical Safety EN61010-1:2001

Safety requirements for electrical equipment for measurement, control and laboratory.

Double Insulation

Pollution Degree 2

Dielectric withstand Test per 1 min

- Power to Input/Output: 2300Vac (3250Vdc)
- Power to Input/Output: 1500Vac (2120Vdc)
(Low Voltage dc Power Option*)
- Power to Relays/SSR Output: 2300Vac (3250Vdc)
- Ethernet to Inputs: 1500Vac (2120Vdc)
- Isolated RS232 to Inputs: 500Vac (720Vdc)
- Isolated Analog to Inputs: 500Vac (720Vdc)
- Analog/Pulse to Inputs: No Isolation

Measurement Category I

Category I are measurements performed on circuits not directly connected to the Mains Supply (power). Maximum Line-to-Neutral working voltage is 50Vac/dc.

This unit should not be used in Measurement Categories II, III, IV.

Transients Overvoltage Surge (1.2 / 50uS pulse)

- Input Power: 2500V
- Input Power: 1500V
(Low Voltage dc Power Option*)
- Ethernet: 1500V
- Input/Output Signals: 500V

Note: *Units configured for external low power dc voltage, 12-36Vdc

EMC EN61326:1997 + and A1:1998 + A2:2001

Immunity and Emissions requirements for electrical equipment for measurement, control and laboratory.

- EMC Emissions Table 4, Class B of EN61326
- EMC Immunity** Table 1 of EN61326

Note: **I/O signal and control lines require shielded cables and these cables must be located on conductive cable trays or in conduits. Furthermore, the length of these cables should not exceed 30 meters



7.2 FCC

Refer to the EMC and Safety installation considerations (Guidelines) of this manual for additional information.

This device complies with Part 15, Subpart B, Class B of the FCC rules.

Warranty/Disclaimer

NEWPORT Electronics, Inc. warrants this unit to be free of defects in materials and workmanship for a period of **one (1) year** from the date of purchase. In addition to NEWPORT's standard warranty period, NEWPORT Electronics will extend the warranty period for **four (4) additional years** if the warranty card enclosed with each instrument is returned to NEWPORT.

If the unit should malfunction, it must be returned to the factory for evaluation. NEWPORT's Customer Service Department will issue an Authorized Return (AR) number immediately upon phone or written request. Upon examination by NEWPORT, if the unit is found to be defective it will be repaired or replaced at no charge. NEWPORT's WARRANTY does not apply to defects resulting from any action of the purchaser, including but not limited to mishandling, improper interfacing, operation outside of design limits, improper repair, or unauthorized modification. This WARRANTY is VOID if the unit shows evidence of having been tampered with or shows evidence of being damaged as a result of excessive corrosion; or current, heat, moisture or vibration; improper specification; misapplication; misuse or other operating conditions outside of NEWPORT's control. Components which wear are not warranted, including but not limited to contact points, fuses, and triacs.

NEWPORT is pleased to offer suggestions on the use of its various products. However, NEWPORT neither assumes responsibility for any omissions or errors nor assumes liability for any damages that result from the use of its products in accordance with information provided by NEWPORT, either verbal or written. NEWPORT warrants only that the parts manufactured by it will be as specified and free of defects. NEWPORT MAKES NO OTHER WARRANTIES OR REPRESENTATIONS OF ANY KIND WHATSOEVER, EXPRESSED OR IMPLIED, EXCEPT THAT OF TITLE, AND ALL IMPLIED WARRANTIES INCLUDING ANY WARRANTY OF MERCHANTABILITY AND FITNESS FOR A PARTICULAR PURPOSE ARE HEREBY DISCLAIMED. LIMITATION OF LIABILITY: The remedies of purchaser set forth herein are exclusive and the total liability of NEWPORT with respect to this order, whether based on contract, warranty, negligence, indemnification, strict liability or otherwise, shall not exceed the purchase price of the component upon which liability is based. In no event shall NEWPORT be liable for consequential, incidental or special damages.

CONDITIONS: Equipment sold by NEWPORT is not intended to be used, nor shall it be used: (1) as a "Basic Component" under 10 CFR 21 (NRC), used in or with any nuclear installation or activity; or (2) in medical applications or used on humans. Should any Product(s) be used in or with any nuclear installation or activity, medical application, or used on humans, or misused in any way, NEWPORT assumes no responsibility as set forth in our basic WARRANTY / DISCLAIMER language, and additionally purchaser will indemnify NEWPORT and hold NEWPORT harmless from any liability or damage whatsoever arising out of the use of the Product(s) in such a manner.

Return Requests/Inquiries

Direct all warranty and repair requests/inquiries to the NEWPORT Customer Service Department. **BEFORE RETURNING ANY PRODUCT(S) TO NEWPORT, PURCHASER MUST OBTAIN AN AUTHORIZED RETURN (AR) NUMBER FROM NEWPORT'S CUSTOMER SERVICE DEPARTMENT (IN ORDER TO AVOID PROCESSING DELAYS).** The assigned AR number should then be marked on the outside of the return package and on any correspondence.

The purchaser is responsible for shipping charges, freight, insurance and proper packaging to prevent breakage in transit.

FOR **WARRANTY** RETURNS, please have the following information available **BEFORE** contacting NEWPORT:

1. P.O. number under which the product was **PURCHASED**,
2. Model and serial number of the product under warranty, and
3. Repair instructions and/or specific problems relative to the product.

FOR **NON-WARRANTY** REPAIRS, consult NEWPORT for current repair charges. Have the following information available **BEFORE** contacting NEWPORT:

1. P.O. number to cover the **COST** of the repair,
2. Model and serial number of product, and
3. Repair instructions and/or specific problems relative to the product.

NEWPORT's policy is to make running changes, not model changes, whenever an improvement is possible. This affords our customers the latest in technology and engineering.

NEWPORT is a registered trademark of NEWPORT Electronics, Inc.

© Copyright 2006 NEWPORT Electronics, Inc. All rights reserved. This document may not be copied, photocopied, reproduced, translated, or reduced to any electronic medium or machine-readable form, in whole or in part, without prior written consent of NEWPORT Electronics, Inc.

For immediate technical or application assistance please call:

1-800-6397678®
1-800-NEWPORT

Newport Electronics, Inc.
2229 South Yale Street • Santa Ana, CA • 92704 • U.S.A.
TEL: (714) 540-4914 • FAX: (203) 968-7311
Toll Free: 1-800-639-7678 • www.newportUS.com • e-mail: info@newportUS.com
ISO 9001 Certified

Newport Technologies, Inc.
976 Bergar • Laval (Quebec) • H7L 5A1 • Canada
TEL: (514) 335-3183 • FAX: (514) 856-6886
Toll Free: 1-800-639-7678 • www.newport.ca • e-mail: info@newport.ca

Newport Electronics, Ltd.
One Omega Drive • River Bend Technology Centre
Northbank, Irlam • Manchester M44 5BD • United Kingdom
Tel: +44 161 777 6611 • FAX: +44 161 777 6622
Toll Free: 0800 488 488 • www.newportuk.co.uk • e-mail: sales@newportuk.co.uk

Newport Electronics spol s.r.o.
Frystatska 184, 733 01 Karviná • Czech Republic
TEL: +420 59 6311899 • FAX: +420 59 6311114
Toll Free: 0800-1-66342 • www.newport.cz • e-mail: info@newport.cz

Newport Electronics GmbH
Daimlerstrasse 26 • D-75392 Deckenpfronn • Germany
TEL: 49 7056 9398-0 • FAX: 49 7056 9398-29
Toll Free: 0800 / 6397678 • www.newport.de • e-mail: sales@newport.de

Mexico and Latin America
FAX: 001 (203) 359-7807
En Español: 001 (203) 359-7803

NEWPORTnetSM On-Line Service www.newportUS.com
--

Internet e-mail info@newportUS.com
--

 **NEWPORT** Electronics, Inc.